



DEGRENE  
PARIS

Since 1948



2024



Plus de 75 ans après sa création, la Maison DEGRENNE, fabricant français d'arts de la table premium, est toujours une entreprise familiale gérée par la famille SPRUCH.

Les 4 frères de la famille : Antoine, Marc-Alain, Benjamin et Thomas, s'engagent tous les jours pour développer et réinventer cette Maison française.

La Maison DEGRENNE perpétue, transmet et revisite les savoir-faire de ses artisans dans ses trois Manufactures : à Vire en Normandie pour les couverts et la platerie, en acier inoxydable et en métal argenté, à Limoges pour la porcelaine fine extra blanche et en Hongrie pour la porcelaine de couleur.

Dans ses Manufactures, DEGRENNE associe le meilleur des deux mondes : l'artisanat et l'industrie, en réinventant des gestes artisanaux et en les adaptant à un process industriel de moyennes séries.

Les savoir-faire des artisans orfèvres et porcelainiers des Manufactures DEGRENNE sont reconnus et sélectionnés par les plus exigeants : les plus beaux hôtels et restaurants, de Paris à New-York City en passant par Séoul, les Maisons de Luxe les plus prestigieuses, les grandes compagnies aériennes.

La famille SPRUCH et toutes les équipes de la Maison DEGRENNE sont fiers de vous accompagner et de vous proposer dans ce catalogue ses collections de couverts, platerie, vaisselle et verrerie, qui marient qualité, intemporalité, design et usage. Ses collections DEGRENNE, toutes au service des Chefs, sont pensées et réalisées pour vous inspirer et pour mettre en valeur vos plus belles créations.

More than 75 years after its creation, the DEGRENNE House, a French manufacturer of premium tableware, remains a family-run business managed by the SPRUCH family.

The four brothers of the family : Antoine, Marc-Alain, Benjamin and Thomas commit themselves every day to developing and reinventing this French Maison.

DEGRENNE perpetuates, transmits, and revisits the expertise of its craftsmen in its three Manufactures: in Vire, Normandy, for cutlery and silverware in stainless steel and silver-plated metal in Limoges for extra-white fine porcelain and in Hungary for colored porcelain.

In its Manufactures, DEGRENNE combines the best of both worlds : craftsmanship and industry, reinventing artisanal gestures and adapting them to a medium-scale industrial process.

The know-how of the goldsmiths and porcelain makers in the DEGRENNE Manufactures is recognized and selected by the most demanding clientele : the finest hotels and restaurants from Paris to New York City to Seoul, as well as the most prestigious Luxury Houses and major airlines.

The SPRUCH family and all the teams at DEGRENNE are proud to accompany and present in this catalog their collections of cutlery, silverware, tableware, and glassware, which blend quality, timelessness, design, and functionality. DEGRENNE collections, all at the service of chefs, are designed and created to inspire you and showcase your most beautiful creations.

PARTENAIRES  
D'  
EXCELLENCE

PARTNERS OF EXCELLENCE



ILS NOUS  
FONT  
CONFIANCE

THEY TRUST US

LE FOUQUET'S  
SOCIÉTÉ DES BAINS DE MER  
LUTETIA  
WALDORF ASTORIA  
PENINSULA  
PLAZA  
ELEVEN MADISON PARK  
BELLAGIO  
MARRIOTT / STARWOOD /  
SHERATON  
FOUR SEASONS  
HILTON WORLDWIDE  
FAIRMONT / RAFFLES HOTELS  
SWISSOTEL  
W HOTELS

ACCOR HOTELS  
PULLMAN  
SOFITEL / BARRIÈRE  
M GALLERY / MAMA SHELTER  
NOVOTEL  
MERCURE  
IBIS  
INTERCONTINENTAL  
RITZ CARLTON  
LOUVRE HOTELS  
GOLDEN TULIP  
CAMPANILE  
KYRIAD

LA VAISSELLE/DINNERWARE

ARTY CREATION	34-35
BAHIA	36-41
BLUE SHADES	42-43
BORÉAL	44-45
BORÉAL SATIN BLANC	46-47
BORÉAL SATIN GOLD	46-47
BRUME	48-49
COCOTTES	50-53
ÉCLIPSE	20-21
GALON OR	22-23
GALON PLATINE	24-25
<b>GRAPHIQUE CLASSIQUE NEW</b>	54-55
<b>GRAPHIQUE DORÉ NEW</b>	54-55
L	10-13
L COUTURE	14-15
L FRAGMENT	16-17
L PERLES DE ROSÉE	18-19
MODULO	56-59
MODULO NATURE	60-63
REMINISCENCE	26-27
<b>RIVAGE NEW</b>	64-65
SD ONE	28-29
SD ONE OR	28-29
SUPERNATURE	30-31
SUPERNATURE OR	30-31

LA CAFÉTERIE/TEATIME

EMPILÉO CAFÉTERIE	74-75
BOREAL SATIN	80
<b>GRAPHIQUE CLASSIQUE NEW</b>	80
L	78
L COUTURE	78
L FRAGMENT	78
L PERLES DE ROSÉE	78
MODULO NATURE	82-83
NEWPORT	80
SALAM	68-71
SALAM MONOCHROME	72-73
SALAM THÉ	76-77
SD ONE	78
SMOOS	80

LE COUVERT/FLATWARE

<b>DESIGN</b>	
AQUATIC MIROIR	88-89
ASTRÉE CISELÉ	94-95
COUTURE	90-91
FUSE MIROIR	96-97
FUSE MARTELÉ	98-99
GUEST CUIVRE	102-103
GUEST MIROIR	100-101
GUEST STAR	104-105
GUEST VINTAGE	106-107
L'EMPREINTE	108-109
L'E STARCK®	110-111
MIRAGE	112-113
NORWAY	114-115
ONDE MIROIR	116-117
ONDE GOLD	118-119
OVATION	120-121
SOLSTICE	122-123
SUPERNATURE	92-93
XY MIROIR	124-125
XY BLACK MIROIR	126-127
<b>CLASSIQUE</b>	
ABSOLU	130-131
BLOIS	132-135
CONFIDENCE	136-137
<b>CONTOUR NEW</b>	138-139
COUTEAUX STEAK	162-165
FLORENCIA	140-141
<b>LE PHIL NEW</b>	162-163
LUTÈCE	142-143
MARQUISE	144-145
MIKADO MIROIR	146-147
MIKADO VINTAGE	148-149
MILADY	150-151
MIRAGE	162-163
MIRAGE LES ESSENCES	162-163
NEUILLY	152-153
NORMANDY	154-155
PETIT GOURMET	168-169
PIÈCES COMPLÉMENTAIRES	166-167
VERLAINE	156-157
VIEUX PARIS SATINÉ	158-159

LA PLATERIE/HOLLOWARE

NEWPORT ACCESSOIRES	182-183
NEWPORT BAR	180-181
NEWPORT CAFÉTERIE	178-179
NEWPORT PLATEAUX CUBIQUE	175
NEWPORT PLATEAUX MIROIR	172-175
NEWPORT SERVICE À TABLE	176-177
NORMANDY	174

LE VERRE/GLASSWARE

ALLURE	186-187
ANYTIME	188-189
CARAFES - DÉCANTEURS	214-215
DOMAINE	190-191
HYPNOTIC JAUGÉ	194
GALATÉE	192-193
MONTMARTRE	194-195
MONTMARTRE JAUGÉ	194
MUSE	196-197
NEWPORT TWIST	198-201
ORIGINE	189

GOBELETS/GLASSES

ALLEGRO	204-205
ALLURE	186
COSMOPOLITAIN	206-207
DOLCE	206-207
EMPILEO	208-209
GALATÉE	192
INSTANT	210-211
LOOP	210-211
MAMBO	212-213
MUSE	196
NEWPORT TWIST	198-201
ROC	212-213

LE BUFFET EVENTO

ACCESSOIRES	236-237
CHAFING DISHES	220-223
DISTRIBUTEURS À CÉRÉALES	229
MODULES FROIDS	224-227
PIÈCES DÉTACHÉES	240-241
PLAN	238-239
PLANCHES LES ESSENCES	234-235
SUPPORTS À FIL RECTANGULAIRES	230-233
SUPPORTS À FIL ROUNDS	230-233
URNES À JUS DE FRUITS	228



AMAZONE	244-245
CASSIOPEE	246-247
ESSENTIELLE	248-249
GLORIA	250-251
UNISSET	252-253
VITAL	254-255
UNI	256-261

COLLECTIONS  
RANGES



© Anne Claire Heraud

A  
V A I S S E L L E  
DINNERWARE

DEGRENNÉ travaille les formes et les matières en portant une attention particulière aux attentes des chefs, tant esthétiques que dans l'usage. Pour faire de la table un moment dédié aux plaisirs gastronomiques, du plus simple au plus élaboré, DEGRENNÉ imagine des collections uniques qui incarnent l'excellence et qui peuvent être associées entre elles. En jouant sur les combinaisons, les contrastes, les formes, les couleurs et les matières, chaque met trouve harmonieusement sa place à table, avec élégance et sobriété. Matières nobles, lignes épurées, épousez tous les savoir-faire DEGRENNÉ lorsque vous dressez votre table.

DEGRENNÉ develops shapes and materials, while paying careful attention to chefs' practical usage and aesthetic requirements. DEGRENNÉ designs unique collections that are the very embodiment of excellence and can also be combined, in order to make dining a moment of culinary pleasure, from the simplest to the most elaborate pleasures. Each dish harmoniously finds its rightful place on the table, with simplicity and elegance, thanks to the combinations, contrasts, shapes, colours and materials employed by DEGRENNÉ. Capitalize on DEGRENNÉ's extensive expertise when setting your table : we offer sleek lines and the finest materials.



# PORCELAINE DE LIMOGES ET EXCELLENCE

LIMOGES PORCELAIN AND EXCELLENCE

Alliez élégance et sobriété grâce à des matières nobles et des formes aux lignes épurées. D'une blancheur et d'une opalescence remarquables, la Porcelaine de Limoges est symbole d'excellence et de pureté.

Combine elegance and simplicity by harnessing the finest materials and sleek lines. Stunning white and milkily iridescent Limoges porcelain is the epitome of excellence and purity.



Découvrez les coulisses de notre manufacture à Limoges  
Discover our factory in Limoges





**ASSIETTE PLATE 227822**  
 ROUND EXT : 32 CM - 12 IN<sup>5/8</sup>  
 DINNER PLATE INT : 19,5 CM - 7 IN<sup>11/16</sup>  
 W/WIDE RIM

**227823**  
 EXT : 28 CM - 11 IN  
 INT : 17 CM - 6 IN<sup>11/16</sup>

**227824**  
 EXT : 24 CM - 9 IN<sup>7/16</sup>  
 INT : 15 CM - 5 IN<sup>7/8</sup>



Compatible avec les assiettes cocottes  
 Compatible with the casserole plates

P 52-53 ●●●●●●●●



**CLOCHE VERRE BOROSILICATE**  
 DOME GLASS  
 COVER **204043**  
 17X9 CM  
 6 IN<sup>11/16</sup> X 3 IN<sup>9/16</sup>

**BOUCHON PORCELAINE**  
 PORCELAIN LID  
**206504**  
 5,2 CM - 2 IN<sup>1/16</sup>



**ASSIETTE 227826**  
**GOURMET** EXT : 30 CM - 11 IN<sup>13/16</sup>  
 ROUND INT : 14 CM - 5 IN<sup>1/2</sup>  
 SHALLOW BOWL  
 W/WIDE RIM

**227827**  
 EXT : 27,9 CM - 10 IN<sup>15/16</sup>  
 INT : 11,5 CM - 4 IN<sup>1/2</sup>



Compatible avec les bols cocottes  
 Compatible with the round casseroles

P 52-53 ●●●●●●●●



**CLOCHE INOX**  
 DOME STAINLESS STEEL  
 COVER **182614**  
 24 CM - Ø 9 IN<sup>7/16</sup>

**182301**  
 14,8 CM - Ø 5 IN<sup>13/16</sup>



**ASSIETTE À PAIN 227825**  
 ROUND BREAD EXT : 14 CM - 5 IN<sup>1/2</sup>  
 & BUTTER PLATE INT : 9,5 CM - 3 IN<sup>3/4</sup>  
 W/WIDE RIM



**TASSE 227828**  
**ESPRESSO** 10 CL - 3 OZ<sup>2/8</sup>  
 DEMITASSE CUP 5,7 CM - 2 IN<sup>1/4</sup>

**SOUCOUPE 227831**  
**ESPRESSO** 12,6 CM  
 DEMITASSE Ø 4 IN<sup>15/16</sup>  
 SAUCER



**TASSE 227829**  
**LUNGO** 25 CL - 8 OZ<sup>7/16</sup>  
 COFFEE/TEA CUP 8,5 CM - 3 IN<sup>3/8</sup>

**SOUCOUPE**  
**LUNGO 227832**  
 COFFEE/TEA 15,8 CM - Ø 6 IN<sup>1/4</sup>  
 SAUCER

# COLLECTION L

Finedining  
 Haute Porcelaine de Limoges  
 High Limoges Porcelain







**ASSIETTE CREUSE 232576**  
**CALOTTE** EXT : 18,5 CM - 7 IN<sup>5/16</sup>  
 ROUND  
 CEREAL PLATE



**PLAT À TARTE 227839**  
 PIE/PIZZA 31,5 CM  
 PLATE, 12 IN<sup>13/32</sup>  
 FLAT



**PLAT ROND 227840**  
**CREUX** 30,5 CM  
 ROUND 12 IN<sup>1/64</sup>  
 DEEP DISH



**PLAT OVALE 227837**  
 OVAL DISH 36,5 X 26,5 CM  
 14 IN<sup>3/8</sup> X 10 IN<sup>7/16</sup>

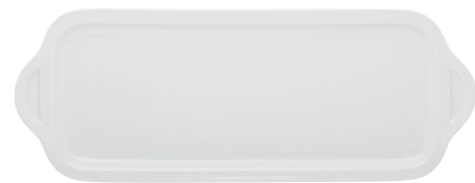

**PLAT À CAKE 227838**  
**RECTANGULAIRE** 35 X 15 CM  
 RECTANGULAR 13 IN<sup>25/32</sup> X 5 IN<sup>1/16</sup>  
 DISH CAKE



**SALADIER 227841**  
 SALAD BOWL 25 CM - 9 IN<sup>13/16</sup>

NEW



**VERSEUSE 245885**  
 SAUCE JUG 13 CM - 4 IN<sup>3/8</sup>



**COUPELLE 227842**  
 SMALL BOWL 13,5 CM - 5 IN<sup>5/16</sup>



**THÉIÈRE 227834**  
 TEA POT 1L - 33 OZ<sup>13/16</sup>  
 H 15,7 CM Ø 12,4 CM  
 H 6 IN<sup>3/16</sup> Ø 4 IN<sup>7/8</sup>



**SUCRIER 227836**  
 SUGAR BOWL 30 CL - 10 OZ<sup>1/8</sup>  
 H 10,8 CM - Ø 9,2 CM  
 H 4 IN<sup>1/4</sup> - Ø 3 IN<sup>5/8</sup>



**CRÉMIER 227835**  
 CREAM JUG 16 CL - 5 OZ<sup>7/16</sup>  
 H 8,5 CM Ø 6,7 CM  
 H 3 IN<sup>3/8</sup> Ø 2 IN<sup>5/8</sup>



# COLLECTION L

Finedining  
 Haute Porcelaine de Limoges  
 High Limoges Porcelain  
 MADE IN FRANCE





BLANC  
WHITE

**ASSIETTE PLATE 237398**  
ROUND DINNER PLATE  
EXT : 32 CM - 12 IN<sup>5/8</sup>  
INT : 19,5 CM - 7 IN<sup>11/16</sup>  
W/WIDE RIM

**237399**  
EXT : 28 CM - 11 IN  
INT : 17 CM - 6 IN<sup>11/16</sup>

**237400**  
EXT : 24 CM - 9 IN<sup>7/16</sup>  
INT : 15 CM - 5 IN<sup>7/8</sup>



IVOIRE  
IVORY

**239328**  
EXT : 32 CM - 12 IN<sup>5/8</sup>  
INT : 19,5 CM - 7 IN<sup>11/16</sup>

**239326**  
EXT : 28 CM - 11 IN  
INT : 17 CM - 6 IN<sup>11/16</sup>

**239327**  
EXT : 24 CM - 9 IN<sup>7/16</sup>  
INT : 15 CM - 5 IN<sup>7/8</sup>



Compatible with the casseroles plates  
Compatible with the casserole plates

P 52-53



**CLOCHE VERRE BOROSILICATE**  
DOME GLASS  
COVER **204043**  
17X9 CM  
6 IN<sup>11/16</sup> X 3 IN<sup>9/16</sup>

**BOUCHON PORCELAINE**  
PORCELAIN LID  
**206504**  
5,2 CM - 2 IN<sup>1/16</sup>



**ASSIETTE GOURMET 237402**  
ROUND SHALLOW BOWL  
EXT : 30 CM - 11 IN<sup>13/16</sup>  
INT : 14 CM - 5 IN<sup>1/2</sup>  
W/WIDE RIM

**237403**  
EXT : 27,9 CM - 10 IN<sup>15/16</sup>  
INT : 11,5 CM - 4 IN<sup>1/2</sup>



**239311**  
EXT : 30 CM - 11 IN<sup>13/16</sup>  
INT : 14 CM - 5 IN<sup>1/2</sup>

**239330**  
EXT : 27,9 CM - 10 IN<sup>15/16</sup>  
INT : 11,5 CM - 4 IN<sup>1/2</sup>

Compatible with the round casseroles  
Compatible with the round casseroles

P 52-53

Compatible with the slanted rim bowls  
Compatible with the slanted rim bowls

P 52-53



**CLOCHE INOX**  
DOME STAINLESS STEEL  
COVER **182614**  
24 CM - Ø 9 IN<sup>7/16</sup>

**182301**  
14,8 CM - Ø 5 IN<sup>13/16</sup>



**ASSIETTE À PAIN 237401**  
ROUND BREAD & BUTTER PLATE  
EXT : 14 CM - 5 IN<sup>1/2</sup>  
INT : 9,5 CM - 3 IN<sup>3/4</sup>  
W/WIDE RIM



**239329**  
EXT : 14 CM - 5 IN<sup>1/2</sup>  
INT : 9,5 CM - 3 IN<sup>3/4</sup>



**TASSE ESPRESSO 227828**  
DEMITASSE CUP  
10 CL - 3 OZ<sup>3/8</sup>  
5,7 CM - 2 IN<sup>1/4</sup>

**SOUCOUE ESPRESSO 237404**  
DEMITASSE SAUCER  
12,6 CM  
Ø 4 IN<sup>15/16</sup>



**TASSE LUNGO 227829**  
COFFEE/TEA CUP  
25 CL - 8 OZ<sup>7/16</sup>  
8,5 CM - 3 IN<sup>3/8</sup>

**SOUCOUE LUNGO 237405**  
COFFEE/TEA SAUCER  
15,8 CM - Ø 6 IN<sup>1/4</sup>



# COLLECTION L COUTURE

Finedining  
Haute Porcelaine de Limoges  
High Limoges Porcelain





**ASSIETTE PLATE 227843**  
 ROUND EXT : 32 CM - 12 IN<sup>5/8</sup>  
 DINNER PLATE INT : 19,5 CM - 7 IN<sup>11/16</sup>  
 W/WIDE RIM

**245599**  
 EXT : 32 CM - 12 IN<sup>5/8</sup>  
 INT : 19,5 CM - 7 IN<sup>11/16</sup>

Compatible avec les assiettes cocottes  
 Compatible with the casserole plates  
 P52-53 ●●●●●●●●

**CLOCHE VERRE BOROSILICATE**  
 DOME GLASS  
 COVER **204043**  
 17X9 CM  
 6 IN<sup>11/16</sup> X 3 IN<sup>9/16</sup>

**227844**  
 EXT : 28 CM - 11 IN  
 INT : 17 CM - 6 IN<sup>11/16</sup>

**245601**  
 EXT : 28 CM - 11 IN  
 INT : 17 CM - 6 IN<sup>11/16</sup>

**227845**  
 EXT : 24 CM - 9 IN<sup>7/16</sup>  
 INT : 15 CM - 5 IN<sup>7/8</sup>

**245603**  
 EXT : 24 CM - 9 IN<sup>7/16</sup>  
 INT : 15 CM - 5 IN<sup>7/8</sup>

**BOUCHON PORCELAINE**  
 PORCELAIN LID  
**206504**  
 5,2 CM - 2 IN<sup>1/16</sup>



**ASSIETTE 227847**  
**GOURMET** EXT : 30 CM - 11 IN<sup>13/16</sup>  
 ROUND INT : 14 CM - 5 IN<sup>1/2</sup>  
 SHALLOW BOWL  
 W/WIDE RIM

**245607**  
 EXT : 30 CM - 11 IN<sup>13/16</sup>  
 INT : 14 CM - 5 IN<sup>1/2</sup>

Compatible avec les bols cocottes  
 Compatible with the round casseroles  
 P52-53 ●●●●●●●●

**CLOCHE INOX**  
 DOME STAINLESS STEEL  
 COVER **182614**  
 24 CM - Ø 9 IN<sup>7/16</sup>

**227848**  
 EXT : 27,9 CM - 10 IN<sup>15/16</sup>  
 INT : 11,5 CM - 4 IN<sup>1/2</sup>

Compatible avec les bols biseautés cocottes  
 Compatible with the slanted rim bowls  
 P52-53 ●●●●●●●●

**182301**  
 14,8 CM - Ø 5 IN<sup>13/16</sup>



**ASSIETTE À PAIN 227846**  
 ROUND BREAD EXT : 14 CM - 5 IN<sup>1/2</sup>  
 & BUTTER PLATE INT : 9,5 CM - 3 IN<sup>3/4</sup>  
 W/WIDE RIM

**TASSE 227828**  
**ESPRESSO** 10 CL - 3 OZ<sup>3/8</sup>  
 DEMITASSE CUP 5,7 CM - 2 IN<sup>1/4</sup>

**TASSE 227829**  
**LUNGO** 25 CL - 8 OZ<sup>7/16</sup>  
 COFFEE/TEA 8,5 CM - 3 IN<sup>3/8</sup>  
 CUP

**SOUCOUPE 227849**  
**ESPRESSO** 12,6 CM  
 DEMITASSE Ø 4 IN<sup>15/16</sup>  
 SAUCER

**227850**  
**SOUCOUPE** 15,8 CM - Ø 6 IN<sup>1/4</sup>  
**LUNGO**  
 COFFEE/TEA  
 SAUCER



# COLLECTION L FRAGMENT

Finedining  
 Haute Porcelaine de Limoges  
 High Limoges Porcelain



L'abus d'alcool est dangereux pour la santé  
 Alcohol is dangerous for your health



**ASSIETTE PLATE 233922**  
 ROUND EXT : 32 CM - 12 IN<sup>5/8</sup>  
 DINNER PLATE INT : 19,5 CM - 7 IN<sup>11/16</sup>  
 W/WIDE RIM

**233923**  
 EXT : 28 CM - 11 IN  
 INT : 17 CM - 6 IN<sup>11/16</sup>

**233924**  
 EXT : 24 CM - 9 IN<sup>7/16</sup>  
 INT : 15 CM - 5 IN<sup>7/8</sup>



Compatible avec les assiettes cocottes  
 Compatible with the casserole plates  
 P 52-53



**CLOCHE VERRE BOROSILICATE**  
 DOME GLASS COVER  
**204043**  
 17X9 CM  
 6 IN<sup>11/16</sup> X 3 IN<sup>9/16</sup>

**BOUCHON PORCELAINE**  
 PORCELAIN LID  
**206504**  
 5,2 CM - 2 IN<sup>1/16</sup>



**ASSIETTE 233926**  
**GOURMET** EXT : 30 CM - 11 IN<sup>13/16</sup>  
 ROUND INT : 14 CM - 5 IN<sup>1/2</sup>  
 SHALLOW BOWL W/WIDE RIM

**233927**  
 EXT : 27,9 CM - 10 IN<sup>15/16</sup>  
 INT : 11,5 CM - 4 IN<sup>1/2</sup>



Compatible avec les bols cocottes  
 Compatible with the round casseroles  
 P 52-53



**CLOCHE INOX**  
 DOME STAINLESS STEEL COVER  
**182614**  
 24 CM - Ø 9 IN<sup>7/16</sup>

**182301**  
 14,8 CM - Ø 5 IN<sup>13/16</sup>



**ASSIETTE À PAIN 233925**  
 ROUND BREAD EXT : 14 CM - 5 IN<sup>1/2</sup>  
 & BUTTER PLATE INT : 9,5 CM - 3 IN<sup>3/4</sup>  
 W/WIDE RIM



**TASSE 227828**  
**ESPRESSO** 10 CL - 3 OZ<sup>3/8</sup>  
 DEMITASSE CUP 5,7 CM - 2 IN<sup>1/4</sup>

**SOUCOUPE 233928**  
**ESPRESSO** 12,6 CM  
 DEMITASSE Ø 4 IN<sup>15/16</sup>  
 SAUCER



**TASSE 227829**  
**LUNGO** 25 CL - 8 OZ<sup>7/16</sup>  
 COFFEE/TEA 8,5 CM - 3 IN<sup>3/8</sup>  
 CUP

**233929**  
**SOUCOUPE LUNGO** 15,8 CM - Ø 6 IN<sup>1/4</sup>  
 COFFEE/TEA SAUCER

# COLLECTION L PERLES DE ROSÉE

Finedining  
 Haute Porcelaine de Limoges  
 High Limoges Porcelain

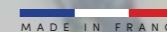



**ASSIETTE PLATE 234605**  
DINNER PLATE EXT : 32 CM - 12 IN<sup>5/8</sup>  
INT : 19 CM - 7 IN<sup>1/2</sup>

**234612**  
EXT : 30 CM - 11 IN<sup>13/16</sup>  
INT : 18 CM - 7 IN<sup>1/16</sup>

**234607**  
EXT : 26,5 CM - 10 IN<sup>2/16</sup>  
INT : 17 CM - 6 IN<sup>11/16</sup>

**234608**  
EXT : 21,5 CM - 8 IN<sup>7/16</sup>  
INT : 13 CM - 5 IN<sup>1/8</sup>

**234611**  
EXT : 18,5 CM - 7 IN<sup>5/16</sup>  
INT : 11 CM - 4 IN<sup>5/16</sup>

**234603**  
EXT : 16 CM - 6 IN<sup>5/16</sup>  
INT : 10 CM - 3 IN<sup>15/16</sup>



**ASSIETTE CREUSE 234609**  
CALOTTE EXT : 19 CM - 7 IN<sup>1/2</sup>  
CEREAL PLATE INT : 12 CM - 4 IN<sup>3/4</sup>



**ASSIETTE CREUSE 234610**  
BORD À AILE EXT : 22,5 CM - 8 IN<sup>7/8</sup>  
ROUND DEEP PLATE INT : 13 CM - 5 IN<sup>1/8</sup>



**PLAT OVALE 234606**  
OVAL DISH 36,5 X 26,5 CM - 14 IN<sup>3/8</sup> X 10 IN<sup>7/16</sup>



**BOL À SALADE 234604**  
AVEC BORD À AILE 17,5 CM - 6 IN<sup>7/8</sup>  
SALAD BOWL WITH RIM

# ECLIPSE

Alldaydining  
Porcelaine  
Porcelain  
MADE IN FRANCE



L'abus d'alcool est dangereux pour la santé  
Alcohol is dangerous for your health

# GALON OR

Finedining  
Haute Porcelaine de Limoges  
High Limoges Porcelain



GALON OR  
GOLD



**ASSIETTE PLATE 241089**  
ROUND DINNER PLATE 32 CM - 12 IN<sup>5/8</sup>

**241090**  
26,5 CM - 10 IN<sup>5/8</sup>

**241091**  
21,5 CM - 8 IN<sup>7/16</sup>



**PLAT OVALE 241095**  
OVAL DISH 36,5 X 26,5 CM - 14 IN<sup>3/8</sup> X 10 IN<sup>7/16</sup>



**PLAT ROND PLAT 241096**  
ROUND CAKE/  
PIE DISH 31,5 CM - 12 IN<sup>3/8</sup>



**ASSIETTE À PAIN 227886**  
ROUND BREAD PLATE 14 CM - 5 IN<sup>1/2</sup>  
**NEW**



**ASSIETTE CREUSE 241092**  
**CALOTTE RONDE 19 CM - 7 IN<sup>1/2</sup>**  
ROUND  
CEREAL PLATE



**SALADIER 241098**  
SALAD BOWL 26 CM - 10 IN<sup>1/4</sup>



**ASSIETTE CREUSE 241097**  
**À AILE RONDE 22,5 CM - 8 IN<sup>7/8</sup>**  
ROUND  
CEREAL PLATE



**COUPELLE 241099**  
ROUND 13,5 CM - 5 IN<sup>5/16</sup>  
SMALL BOWL



**TASSE À CAFÉ 241093**  
COFFEE CUP 10 CL - 3 OZ<sup>3/8</sup>



**TASSE À THÉ 241104**  
COFFEE/TEA CUP 20 CL - 6 OZ<sup>3/4</sup>



**TASSE DÉJEUNER 241102**  
BREAKFAST CUP 40 CL - 13 OZ<sup>1/2</sup>

**SOUCOUE À CAFÉ 241094**  
COFFEE SAUCER 12,5 CM - Ø 4 IN<sup>5/16</sup>

**SOUCOUE À THÉ 241105**  
COFFEE/TEA SAUCER 15 CM - Ø 5 IN<sup>7/8</sup>

**SOUCOUE DÉJEUNER 241103**  
BREAKFAST SAUCER 19 CM - 7 IN<sup>1/2</sup>



**THÉIÈRE 241100**  
COFFEE/TEA POT 1 L - 33 OZ<sup>13/16</sup>



**SUCRIER 241101**  
SUGAR BOWL 15 CL - 5 OZ<sup>1/16</sup>



GALON PLATINE  
PLATINIUM



**ASSIETTE PLATE 190054**  
ROUND DINNER PLATE 32 CM - 12 IN<sup>5/8</sup>

**190050**  
26,5 CM - 10 IN<sup>5/8</sup>

**190051**  
21,5 CM - 8 IN<sup>7/16</sup>



**PLAT OVALE 190069**  
OVAL DISH 36,5 X 26,5 CM - 14 IN<sup>3/8</sup> X 10 IN<sup>7/16</sup>



**PLAT ROND PLAT 190068**  
ROUND CAKE/  
PIE DISH 31,5 CM - 12 IN<sup>3/8</sup>



**ASSIETTE CREUSE 190052**  
**CALOTTE RONDE** 19 CM - 7 IN<sup>1/2</sup>  
ROUND  
CEREAL PLATE



**SALADIER 190071**  
SALAD BOWL 26 CM - 10 IN<sup>1/4</sup>



**ASSIETTE CREUSE 190053**  
**À AILE RONDE** 22,5 CM - 8 IN<sup>7/8</sup>  
ROUND  
CEREAL PLATE



**COUPELLE 190070**  
ROUND  
SMALL BOWL 13,5 CM - 5 IN<sup>5/16</sup>



**TASSE À CAFÉ 203238**  
COFFEE CUP 10 CL - 3 OZ<sup>3/8</sup>



**TASSE À THÉ 203240**  
COFFEE/TEA CUP 20 CL - 6 OZ<sup>3/4</sup>



**TASSE DÉJEUNER 203242**  
BREAKFAST CUP 40 CL - 13 OZ<sup>1/2</sup>

**SOUCOUE À CAFÉ 203239**  
COFFEE SAUCER 12,5 CM - Ø 4 IN<sup>15/16</sup>

**SOUCOUE À THÉ 203241**  
COFFEE/TEA SAUCER 15 CM - Ø 5 IN<sup>7/8</sup>

**SOUCOUE DÉJEUNER 203243**  
BREAKFAST SAUCER 19 CM - 7 IN<sup>1/2</sup>



**THÉIÈRE 203245**  
COFFEE/TEA POT 1 L - 33 OZ<sup>13/16</sup>



**SUCRIER 203250**  
SUGAR BOWL 15 CL - 5 OZ<sup>1/16</sup>



# GALON PLATINE

Finedining  
Haute Porcelaine de Limoges  
High Limoges Porcelain  
MADE IN FRANCE



L'abus d'alcool est dangereux pour la santé  
Alcohol is dangerous for your health



**ASSIETTE PLATE 244638**  
ROUND DINNER PLATE 26 CM - 10 IN<sup>1/4</sup>

**244636**  
21,5 CM - 8 IN<sup>7/16</sup>



**ASSIETTE COUPE 244640**  
**RONDE** 19 CM - 7 IN<sup>1/2</sup>  
ROUND COUPE PLATE



# REMINISCENCE

Finedining  
Haute Porcelaine de Limoges  
High Limoges Porcelain



MADE IN FRANCE





SD ONE BLANC  
WHITE



**ASSIETTE PLATE 241052**  
ROUND DINNER PLATE 32 CM - 12 IN<sup>5/8</sup>  
W/WIDE RIM

**241050**  
27 CM - 10 IN<sup>5/8</sup>

**241051**  
21,5 CM - 8 IN<sup>7/16</sup>

**242916**  
14 CM - 5 IN<sup>1/2</sup>

SD ONE OR  
GOLD



**242547**  
32 CM - 12 IN<sup>5/8</sup>

**241053**  
27 CM - 10 IN<sup>5/8</sup>

**241054**  
21,5 CM - 8 IN<sup>7/16</sup>



**SD ONE**

Finedining  
Haute Porcelaine de Limoges  
High Limoges Porcelain



**ASSIETTE COUPE 241048**  
SHALLOW COUPE 25 CM - 9 IN<sup>13/16</sup>  
BOWL, LARGE

SHALLOW COUPE **241049**  
BOWL, MEDIUM 19 CM - 7 IN<sup>1/2</sup>



**BOL 241143**  
BOWL 14 CM - 5 IN<sup>1/2</sup>  
55 CL - 18 OZ<sup>5/8</sup>



**TASSE ESPRESSO 242910**  
ESPRESSO CUP H 6,3 CM - 2 IN<sup>1/2</sup>  
Ø 6 CM - 2 IN<sup>3/8</sup>  
7 CL - 2 OZ<sup>3/8</sup>



**TASSE THÉ/CAFÉ 242912**  
TEA/COFFEE CUP H 8 CM - 3 IN<sup>1/8</sup>  
Ø 7,8 CM - 3 IN<sup>1/16</sup>  
15 CL - 5 OZ<sup>1/16</sup>

**SOUCOUBE 242914**  
SAUCER Ø 14 CM - 5 IN<sup>1/2</sup>



SUPERNATURE



**ASSIETTE PLATE 242906**  
ROUND DINNER PLATE 32 CM - 12 IN<sup>5/8</sup>

**242330**  
27 CM - 10 IN<sup>5/8</sup>

**242331**  
21,5 CM - 8 IN<sup>7/16</sup>

SUPERNATURE OR



**ASSIETTE PLATE 244121**  
ROUND DINNER PLATE 27 CM - 10 IN<sup>5/8</sup>



**ASSIETTE DESSERT 244120**  
ROUND DESSERT PLATE 21,5 CM - 8 IN<sup>7/16</sup>



Compatible avec l'assiette coupe  
de la collection SD ONE  
Compatible with the plates  
of SD ONE collection



**ASSIETTE COUPE 241048**  
SHALLOW COUPE 25 CM - 9 IN<sup>13/16</sup>  
BOWL, LARGE

**SHALLOW COUPE 241049**  
BOWL, MEDIUM 19 CM - 7 IN<sup>1/2</sup>



# SUPERNATURE

Finedining  
Haute Porcelaine de Limoges  
High Limoges Porcelain



MADE IN FRANCE





A  
C É R A M I Q U E  
CERAMIC

En porcelaine ou en grès, des iconiques COCOTTES BAHIA jusqu'à nos assiettes BLUE SHADES, nos collections de céramiques se déclinent en une multitude de formats et de couleurs et s'adaptent à vos besoins pour dresser vos tables du quotidien ou des grandes occasions.

In porcelain or stoneware, from the iconic COCOTTES BAHIA to our BLUE SHADES plates, our ceramic collections are available in a multitude of formats and colors and adapt to your needs to set your tables for everyday life or special occasions.

BLANC  
WHITE

NOIR  
BLACK

# ARTY CREATION

Finedining

Porcelaine  
Porcelain

MADE IN EUROPE

ASSIETTE PLATE  
ROUND DINNER PLATE



SKYLINE

239210  
29 CM - 11 IN <sup>7</sup>/<sub>16</sub>

239214  
29 CM - 11 IN <sup>7</sup>/<sub>16</sub>

240505  
20 CM - 7 IN <sup>7</sup>/<sub>8</sub>

240509  
20 CM - 7 IN <sup>7</sup>/<sub>8</sub>



CIRCLE

239211  
29 CM - 11 IN <sup>7</sup>/<sub>16</sub>

239215  
29 CM - 11 IN <sup>7</sup>/<sub>16</sub>

240506  
20 CM - 7 IN <sup>7</sup>/<sub>8</sub>

240510  
20 CM - 7 IN <sup>7</sup>/<sub>8</sub>



BRUSH

239209  
29 CM - 11 IN <sup>7</sup>/<sub>16</sub>

239213  
29 CM - 11 IN <sup>7</sup>/<sub>16</sub>

240504  
20 CM - 7 IN <sup>7</sup>/<sub>8</sub>

240508  
20 CM - 7 IN <sup>7</sup>/<sub>8</sub>

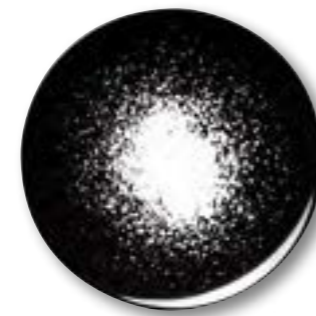

SPLASH

239208  
29 CM - 11 IN <sup>7</sup>/<sub>16</sub>

239212  
29 CM - 11 IN <sup>7</sup>/<sub>16</sub>

240503  
20 CM - 7 IN <sup>7</sup>/<sub>8</sub>

240507  
20 CM - 7 IN <sup>7</sup>/<sub>8</sub>





# BAHIA

Alldaydining  
 Porcelaine - Grès  
 Porcelain - Stoneware  
 MADE IN EUROPE



PIERRE DE LUNE  
 MOONSTONE  
 Porcelaine - Porcelain



DUNE  
 BEIGE DUNE  
 Grès - Stoneware



BLEU DE ROCHE  
 BLUE STONE  
 Grès - Stoneware



ARGILE VERTE  
 GREEN CLAY  
 Grès - Stoneware



ONYX  
 BLACK ONYX  
 Grès - Stoneware

PIERRE DE LUNE  
MOONSTONE  
Porcelaine - Porcelain



**ASSIETTE  
PLATE**  
ROUND  
DINNER PLATE

**239318**  
EXT : 29 CM - 11 IN<sup>7/16</sup>  
INT : 25,5 CM - 10 IN<sup>1/16</sup>

**239317**  
EXT : 26 CM - 10 IN<sup>1/4</sup>  
INT : 22 CM - 8 IN<sup>11/16</sup>

**239316**  
EXT : 23 CM - 9 IN<sup>1/16</sup>  
INT : 19,5 CM - 7 IN<sup>11/16</sup>

DUNE  
BEIGE DUNE  
Grés - Stoneware



**230921**  
EXT : 29 CM - 11 IN<sup>7/16</sup>  
INT : 25,5 CM - 10 IN<sup>1/16</sup>

**230920**  
EXT : 26 CM - 10 IN<sup>1/4</sup>  
INT : 22 CM - 8 IN<sup>11/16</sup>

**230919**  
EXT : 23 CM - 9 IN<sup>1/16</sup>  
INT : 19,5 CM - 7 IN<sup>11/16</sup>

BLEU DE ROCHE  
BLUE STONE  
Grés - Stoneware



**230966**  
EXT : 29 CM - 11 IN<sup>7/16</sup>  
INT : 25,5 CM - 10 IN<sup>1/16</sup>

**230965**  
EXT : 26 CM - 10 IN<sup>1/4</sup>  
INT : 22 CM - 8 IN<sup>11/16</sup>

**230964**  
EXT : 23 CM - 9 IN<sup>1/16</sup>  
INT : 19,5 CM - 7 IN<sup>11/16</sup>

ARGILE VERTE  
GREEN CLAY  
Grés - Stoneware



**230952**  
EXT : 29 CM - 11 IN<sup>7/16</sup>  
INT : 25,5 CM - 10 IN<sup>1/16</sup>

**230951**  
EXT : 26 CM - 10 IN<sup>1/4</sup>  
INT : 22 CM - 8 IN<sup>11/16</sup>

**230950**  
EXT : 23 CM - 9 IN<sup>1/16</sup>  
INT : 19,5 CM - 7 IN<sup>11/16</sup>

ONYX  
BLACK ONYX  
Grés - Stoneware



**236549**  
EXT : 29 CM - 11 IN<sup>7/16</sup>  
INT : 25,5 CM - 10 IN<sup>1/16</sup>

**236548**  
EXT : 26 CM - 10 IN<sup>1/4</sup>  
INT : 22 CM - 8 IN<sup>11/16</sup>

**236547**  
EXT : 23 CM - 9 IN<sup>1/16</sup>  
INT : 19,5 CM - 7 IN<sup>11/16</sup>



**ASSIETTE  
À PAIN**  
ROUND  
BREAD PLATE

**239315**  
EXT : 14 CM - 5 IN<sup>1/2</sup>  
INT : 10 CM - 3 IN<sup>15/16</sup>



**230918**  
EXT : 14 CM - 5 IN<sup>1/2</sup>  
INT : 10 CM - 3 IN<sup>15/16</sup>



**230963**  
EXT : 14 CM - 5 IN<sup>1/2</sup>  
INT : 10 CM - 3 IN<sup>15/16</sup>



**230949**  
EXT : 14 CM - 5 IN<sup>1/2</sup>  
INT : 10 CM - 3 IN<sup>15/16</sup>



**236546**  
EXT : 14 CM - 5 IN<sup>1/2</sup>  
INT : 10 CM - 3 IN<sup>15/16</sup>



**ASSIETTE  
CREUSE**  
ROUND  
CEREAL PLATE

**239319**  
45 CL - 15 OZ<sup>3/16</sup>  
EXT : 20 CM - 7 IN<sup>7/8</sup>  
INT : 16,5 CM - 6 IN<sup>1/2</sup>



**230922**  
45 CL - 15 OZ<sup>3/16</sup>  
EXT : 20 CM - 7 IN<sup>7/8</sup>  
INT : 16,5 CM - 6 IN<sup>1/2</sup>



**230967**  
45 CL - 15 OZ<sup>3/16</sup>  
EXT : 20 CM - 7 IN<sup>7/8</sup>  
INT : 16,5 CM - 6 IN<sup>1/2</sup>



**230953**  
45 CL - 15 OZ<sup>3/16</sup>  
EXT : 20 CM - 7 IN<sup>7/8</sup>  
INT : 16,5 CM - 6 IN<sup>1/2</sup>



**236550**  
45 CL - 15 OZ<sup>3/16</sup>  
EXT : 20 CM - 7 IN<sup>7/8</sup>  
INT : 16,5 CM - 6 IN<sup>1/2</sup>

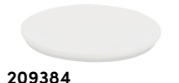

**ASSIETTE  
COUVERCLE**  
ROUND PLATE/  
CASSEROLE LID

**209384**  
12,5 CM - 4 IN<sup>15/16</sup>



**230928**  
12,5 CM - 4 IN<sup>15/16</sup>



**230973**  
12,5 CM - 4 IN<sup>15/16</sup>

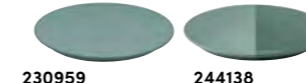

**230959**  
12,5 CM - 4 IN<sup>15/16</sup>

**244138**  
BI FINITION  
DUAL FINISH

LIMITED STOCK



**236556**  
12,5 CM - 4 IN<sup>15/16</sup>

**BOL COCOTTE**  
ROUND  
CASSEROLE

**209720**  
50 CL - 16 OZ<sup>15/16</sup>  
14 CM - 5 IN<sup>1/2</sup>

**230927**  
50 CL - 16 OZ<sup>15/16</sup>  
14 CM - 5 IN<sup>1/2</sup>

**230972**  
50 CL - 16 OZ<sup>15/16</sup>  
14 CM - 5 IN<sup>1/2</sup>

**230958**  
50 CL - 16 OZ<sup>15/16</sup>  
14 CM - 5 IN<sup>1/2</sup>

**236555**  
50 CL - 16 OZ<sup>15/16</sup>  
14 CM - 5 IN<sup>1/2</sup>



**BOL  
BISEAUTÉ  
COCOTTE**  
SLANTED  
RIM BOWL

**211893** **211892**  
30 CL - 10 OZ<sup>1/8</sup> 7 CL - 2 OZ<sup>3/8</sup>  
12 CM - 4 IN<sup>3/4</sup> 7,3 CM - 2 IN<sup>7/8</sup>



**230926** **230925**  
30 CL - 10 OZ<sup>1/8</sup> 7 CL - 2 OZ<sup>3/8</sup>  
12 CM - 4 IN<sup>3/4</sup> 7,3 CM - 2 IN<sup>7/8</sup>



**230971** **230970**  
30 CL - 10 OZ<sup>1/8</sup> 7 CL - 2 OZ<sup>3/8</sup>  
12 CM - 4 IN<sup>3/4</sup> 7,3 CM - 2 IN<sup>7/8</sup>



**230957** **230956**  
30 CL - 10 OZ<sup>1/8</sup> 7 CL - 2 OZ<sup>3/8</sup>  
12 CM - 4 IN<sup>3/4</sup> 7,3 CM - 2 IN<sup>7/8</sup>



**236554** **236553**  
30 CL - 10 OZ<sup>1/8</sup> 7 CL - 2 OZ<sup>3/8</sup>  
12 CM - 4 IN<sup>3/4</sup> 7,3 CM - 2 IN<sup>7/8</sup>



**ASSIETTE  
GOURMET**  
ROUND  
GOURMET  
PLATE

**239321**  
GRAND BASSIN  
W/WIDE ROUND RIM  
EXT : 26 CM - 10 IN<sup>1/4</sup>  
INT : 14 CM - 5 IN<sup>1/2</sup>

**239320**  
PETIT BASSIN  
W/WIDE ROUND RIM  
EXT : 23 CM - 9 IN<sup>1/16</sup>  
INT : 11,5 CM - 4 IN<sup>1/2</sup>



**230924**  
GRAND BASSIN  
W/WIDE ROUND RIM  
EXT : 26 CM - 10 IN<sup>1/4</sup>  
INT : 14 CM - 5 IN<sup>1/2</sup>

**230923**  
PETIT BASSIN  
W/WIDE ROUND RIM  
EXT : 23 CM - 9 IN<sup>1/16</sup>  
INT : 11,5 CM - 4 IN<sup>1/2</sup>



**230969**  
GRAND BASSIN  
W/WIDE ROUND RIM  
EXT : 26 CM - 10 IN<sup>1/4</sup>  
INT : 14 CM - 5 IN<sup>1/2</sup>

**230968**  
PETIT BASSIN  
W/WIDE ROUND RIM  
EXT : 23 CM - 9 IN<sup>1/16</sup>  
INT : 11,5 CM - 4 IN<sup>1/2</sup>



**230955**  
GRAND BASSIN  
W/WIDE ROUND RIM  
EXT : 26 CM - 10 IN<sup>1/4</sup>  
INT : 14 CM - 5 IN<sup>1/2</sup>

**230954**  
PETIT BASSIN  
W/WIDE ROUND RIM  
EXT : 23 CM - 9 IN<sup>1/16</sup>  
INT : 11,5 CM - 4 IN<sup>1/2</sup>



**236552**  
GRAND BASSIN  
W/WIDE ROUND RIM  
EXT : 26 CM - 10 IN<sup>1/4</sup>  
INT : 14 CM - 5 IN<sup>1/2</sup>

**236551**  
PETIT BASSIN  
W/WIDE ROUND RIM  
EXT : 23 CM - 9 IN<sup>1/16</sup>  
INT : 11,5 CM - 4 IN<sup>1/2</sup>



**ASSIETTE COUVERCLE**  
ROUND PLATE/CASSEROLE LID

**BOL COCOTTE**  
ROUND CASSEROLE

**ASSIETTE GOURMET  
GRAND BASSIN**  
ROUND GOURMET PLATE  
W/WIDE ROUND RIM



**ASSIETTE GOURMET  
PETIT BASSIN**  
ROUND GOURMET PLATE  
W/WIDE ROUND RIM

**BOL BISEAUTÉ COCOTTE**  
SLANTED RIM BOWL



**ACCESSOIRES ACCESSORIES**

PIERRE DE LUNE  
MOONSTONE  
Porcelaine - Porcelain



**SALADIER 239325**  
BOWL 28 CM - 11 IN

DUNE  
BEIGE DUNE  
Grès - Stoneware



**235223**  
28 CM - 11 IN

BLEU DE ROCHE  
BLUE STONE  
Grès - Stoneware



**235222**  
28 CM - 11 IN

ONYX  
BLACK ONYX  
Grès - Stoneware



**240499**  
28 CM - 11 IN

VERT ARGILE  
GREEN CLAY  
Grès - Stoneware



**234949**  
25 X 13,5 CM  
9 IN<sup>13/16</sup> X 5 IN<sup>5/16</sup>



**PLANCHE 242054**  
RECTANGULAIRE 35 x 21 CM  
RECTANGULAR BOARD  
13 IN<sup>3/4</sup> X 8 IN<sup>1/4</sup>



**242056**  
35 x 21 CM  
13 IN<sup>3/4</sup> X 8 IN<sup>1/4</sup>



**242052**  
35 x 21 CM  
13 IN<sup>3/4</sup> X 8 IN<sup>1/4</sup>



**237206**  
25 X 13,5 CM  
9 IN<sup>13/16</sup> X 5 IN<sup>5/16</sup>



**PLANCHE 242055**  
RONDE 29 CM - 11 IN<sup>7/16</sup>  
ROUND BOARD



**242057**  
29 CM - 11 IN<sup>7/16</sup>

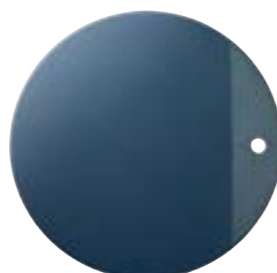

**242053**  
29 CM - 11 IN<sup>7/16</sup>



**PLAT 241835**  
GRAND 31,8 x 25 x 7,4 CM  
MODÈLE 12 IN<sup>1/2</sup> x 9 IN<sup>13/16</sup> x 2 IN<sup>15/16</sup>  
LARGE DISH

---

**PLAT 241834**  
MOYEN 22,8 x 16,2 x 5,4 CM  
MODÈLE 9 IN x 6 IN<sup>3/8</sup> x 2 IN<sup>1/8</sup>  
MEDIUM DISH

---

**PLAT 241833**  
PETIT 15,5 x 10,7 x 4,4 CM  
MODÈLE 6 IN<sup>2/8</sup> x 4 IN<sup>3/16</sup> x 1 IN<sup>3/4</sup>  
SMALL DISH

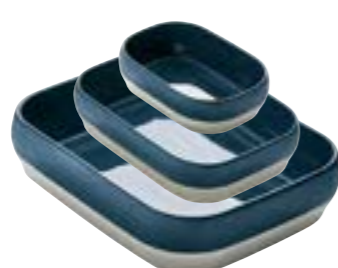

**237595**  
31,8 x 25 x 7,4 CM  
12 IN<sup>1/2</sup> x 9 IN<sup>13/16</sup> x 2 IN<sup>15/16</sup>

---

**237594**  
22,8 x 16,2 x 5,4 CM  
9 IN x 6 IN<sup>3/8</sup> x 2 IN<sup>1/8</sup>

---

**237593**  
15,5 x 10,7 x 4,4 CM  
6 IN<sup>2/8</sup> x 4 IN<sup>3/16</sup> x 1 IN<sup>3/4</sup>

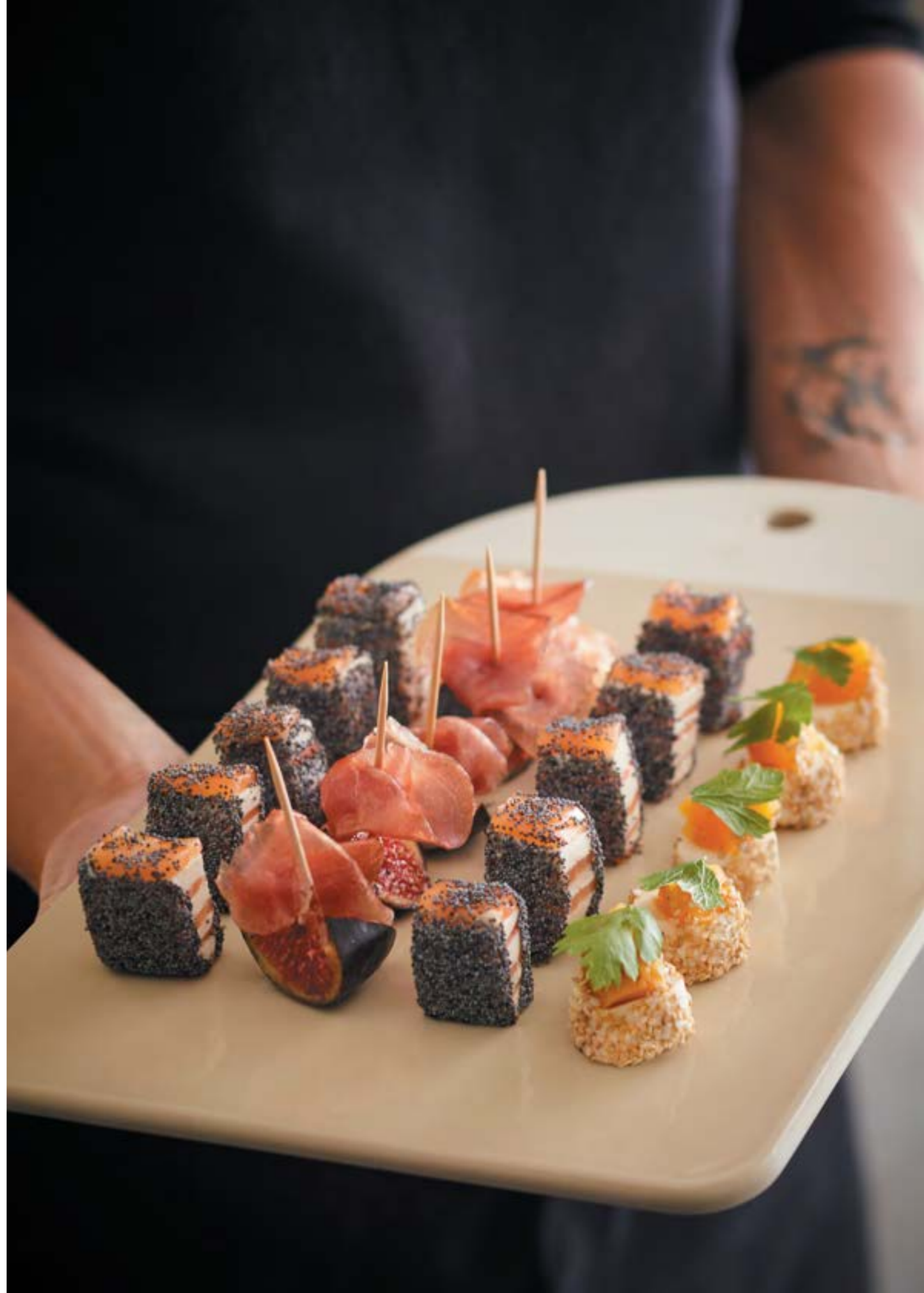

BLUE SHADES HALO  
BLUE SHADES HALO



**ASSIETTE PLATE** 240242  
ROUND DINNER PLATE EXT : 29 CM - 11 IN <sup>7</sup>/<sub>16</sub>

240243  
EXT : 26 CM - 10 IN <sup>1</sup>/<sub>4</sub>

240244  
EXT : 23 CM - 9 IN <sup>1</sup>/<sub>16</sub>

BLUE SHADES AQUARELLE  
BLUE SHADES WATERCOLOR

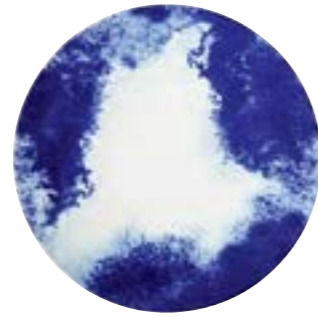

239661  
EXT : 26 CM - 10 IN <sup>1</sup>/<sub>4</sub>

239662  
EXT : 23 CM - 9 IN <sup>1</sup>/<sub>16</sub>



**BOL COCOTTE** 239658  
+ **ASSIETTE/COUVERCLE** 14 CM - 5 IN <sup>1</sup>/<sub>2</sub> - 50 CL - 16 OZ <sup>15</sup>/<sub>16</sub>  
ROUND CASSEROLE  
+240245  
+ ROUND PLATE 12,5 CM - 4 IN <sup>15</sup>/<sub>16</sub>  
CASSEROLE LID



**BOL COCOTTE** 239659  
ROUND CASSEROLE 17,5 CM - 6 IN <sup>7</sup>/<sub>8</sub>  
140 CL - 47 OZ <sup>5</sup>/<sub>16</sub>



**BOL BISEAUTÉ COCOTTE** 239660  
SLANTED RIM BOWL 7,5 CM - 2 IN <sup>15</sup>/<sub>16</sub>  
7 CL - 2 OZ <sup>3</sup>/<sub>8</sub>



**BOL À DÉJEUNER** 239657  
BREAKFAST BOWL 14 CM - 5 IN <sup>1</sup>/<sub>2</sub>  
55 CL - 18 OZ <sup>5</sup>/<sub>8</sub>

# BLUE SHADES

Finedining

Porcelaine  
Porcelain

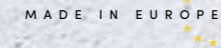





**ASSIETTE PLATE 186770**  
**RONDE** 32,5 CM  
 ROUND 12 IN<sup>13/16</sup>  
 DINNER PLATE  
 W/WIDE RIM

**186765**  
 27,9 CM  
 10 IN<sup>15/16</sup>

**186767**  
 22,5 CM  
 8 IN<sup>7/8</sup>



**ASSIETTE 207140**  
**À PÂTES/SOUBE** EXT : 29,5 CM - 11 IN<sup>5/8</sup>  
 ROUND SOUP/PASTA INT : 17 CM - 6 IN<sup>11/16</sup>  
 BOWL W/WIDE RIM



**ASSIETTE À PAIN 187263**  
 ROUND 15 CM  
 BREAD PLATE 5 IN<sup>7/8</sup>  
 W/WIDE RIM



**ASSIETTE 207136**  
**CALOTTE OVALE** EXT : 23,5 X 20 CM  
 OVAL 9 IN<sup>1/4</sup> X 7 IN<sup>7/8</sup>  
 SHALLOW BOWL,  
 COUPE



**ASSIETTE 246215**  
**CREUSE** 20 CM - 7 IN<sup>7/8</sup>  
 SHALLOW  
 PLATE



**ASSIETTE GOURMET 204040**  
**OVALE GRAND BASSIN** EXT : 32 X 27 CM - 12 IN<sup>5/8</sup> X 10 IN<sup>5/8</sup>  
 SHALLOW BOWL INT : 14,5 CM - 5 IN<sup>5/16</sup>  
 W/WIDE OVAL RIM 27 CL - 9 OZ<sup>1/8</sup>

**ASSIETTE GOURMET 207138**  
**OVALE PETIT BASSIN** EXT : 30 X 26 CM - 11 IN<sup>13/16</sup> X 10 IN<sup>1/4</sup>  
 SHALLOW BOWL INT : 13,5 CM - 5 IN<sup>5/16</sup>  
 W/WIDE OVAL RIM 17 CL - 5 OZ<sup>3/4</sup>



Compatible avec les bols cocottes  
 Compatible with the round casseroles  
 P52-53

Compatible avec les bols biseautés cocottes  
 Compatible with the slanted rim bowls  
 P52-53



**CLOCHE VERRE BOROSILICATE**  
 DOME GLASS  
 COVER **204043**  
 17X9 CM  
 6 IN<sup>11/16</sup> X 3 IN<sup>9/16</sup>

**BOUCHON PORCELAINE**  
 PORCELAIN LID  
**206504**  
 5,2 CM - 2 IN<sup>1/16</sup>



**CLOCHE INOX**  
 DOME STAINLESS STEEL  
 COVER **182614**  
 24 CM - Ø 9 IN<sup>7/16</sup>

**182301**  
 14,8 CM - Ø 5 IN<sup>13/16</sup>



# BORÉAL

Finedining  
 Porcelaine  
 Porcelain  
 MADE IN EUROPE





**ASSIETTE PLATE 193319**  
DINNER PLATE  
W/WIDE RIM  
EXT : 33 CM - 13 IN  
INT : 20 CM - 7 IN<sup>7/8</sup>

225193

**ASSIETTE 223954**  
À PÂTES/SOUPÉ  
ROUND SOUP/PASTA  
BOWL W/WIDE RIM  
EXT : 29 CM - 11 IN<sup>7/16</sup>  
INT : 16 CM - 6 IN<sup>5/16</sup>

**ASSIETTE À PAIN 202470**  
ROUND BREAD  
& BUTTER PLATE  
W/WIDE RIM  
EXT : 15 CM  
5 IN<sup>7/8</sup>

225196

**193318**  
EXT : 27,9 CM - 10 IN<sup>15/16</sup>  
INT : 18,5 CM - 7 IN<sup>5/16</sup>

225194

**193320**  
EXT : 22,5 CM - 8 IN<sup>7/8</sup>  
INT : 14,5 CM - 5 IN<sup>11/16</sup>

225195



**ASSIETTE GOURMET 207769**  
OVALE GRAND BASSIN  
SHALLOW BOWL  
W/WIDE OVAL RIM  
EXT : 32 X 27 CM  
12 IN<sup>5/8</sup> X 10 IN<sup>5/8</sup>  
INT : 14,5 CM - 5 IN<sup>5/16</sup>  
27 CL - 9 OZ<sup>1/8</sup>

Compatible avec les bols cocottes  
Compatible with the round casseroles  
P 52-53

**CLOCHE INOX**  
DOME  
COVER  
STAINLESS STEEL  
**182614**  
24 CM - Ø 9 IN<sup>7/16</sup>

**ASSIETTE GOURMET 193324**  
OVALE PETIT BASSIN  
SHALLOW BOWL  
W/WIDE OVAL RIM  
EXT : 30 X 26 CM  
11 IN<sup>13/16</sup> X 10 IN<sup>1/4</sup>  
INT : 13,5 CM - 5 IN<sup>5/16</sup>  
17 CL - 5 OZ<sup>3/4</sup>

225197

Compatible avec les bols biseautés cocottes  
Compatible with the slanted rim bowls  
P 52-53

**182301**  
14,8 CM - Ø 5 IN<sup>13/16</sup>



**CLOCHE VERRE BOROSILICATE**  
DOME  
COVER  
GLASS  
**204043**  
17X9 CM  
6 IN<sup>11/16</sup> X 3 IN<sup>9/16</sup>

**BOUCHON PORCELAINE**  
PORCELAIN LID  
**206504**  
5,2 CM - 2 IN<sup>1/16</sup>



**TASSE À CAFÉ 186791**  
DEMITASSE CUP  
9 CL - 3 OZ<sup>1/16</sup>



**TASSE À THÉ 186793**  
COFFEE/TEA CUP  
15 CL - 6 OZ<sup>3/4</sup>



**TASSE DÉJEUNER 186795**  
BREAKFAST CUP  
40 CL - 13 OZ<sup>1/2</sup>

**SOUCOUE À CAFÉ 193321**  
DEMITASSE SAUCER  
14X12 CM  
Ø 5 IN<sup>1/2</sup> X 4 IN<sup>3/4</sup>

**SOUCOUE À THÉ 193322**  
COFFEE/TEA SAUCER  
16,5 X 14 CM  
Ø 6 IN<sup>1/2</sup> X 5 IN<sup>1/2</sup>

**SOUCOUE DÉJEUNER 193323**  
BREAKFAST SAUCER  
20X17 CM  
Ø 7 IN<sup>7/8</sup> X 6 IN<sup>11/16</sup>



# BORÉAL SATIN

Finedining  
Porcelaine  
Porcelain  
MADE IN EUROPE



L'abus d'alcool est dangereux pour la santé  
Alcohol abuse is dangerous for your health

ROSÉE  
PINK



SABLE  
SAND



LAIT  
WHITE MILK  
**NEW**



**ASSIETTE** 241267  
**PLATE** 26 CM - 10 IN<sup>1/4</sup>  
ROUND  
DINNER  
**PLATE** 241268  
20 CM - 7 IN<sup>7/8</sup>

**241275**  
26 CM - 10 IN<sup>1/4</sup>  
**241276**  
20 CM - 7 IN<sup>7/8</sup>

**244749**  
26 CM - 10 IN<sup>1/4</sup>  
**244751**  
20 CM - 7 IN<sup>7/8</sup>



**BOL** 241269  
**BOWL** 20 CM - 7 IN<sup>7/8</sup>  
88 CL - 29 OZ<sup>3/4</sup>



**241277**  
20 CM - 7 IN<sup>7/8</sup>  
88 CL - 29 OZ<sup>3/4</sup>



**244753**  
20 CM - 7 IN<sup>7/8</sup>  
88 CL - 29 OZ<sup>3/4</sup>



**COUPELLE** 241270  
**SMALL** 12,5 CM - 4 IN<sup>15/16</sup>  
**BOWL** 23 CL - 7 OZ<sup>3/4</sup>



**241278**  
12,5 CM - 4 IN<sup>15/16</sup>  
23 CL - 7 OZ<sup>3/4</sup>



**244755**  
12,5 CM - 4 IN<sup>15/16</sup>  
23 CL - 7 OZ<sup>3/4</sup>

# BRUME





Alldaydining  
Grès  
Stoneware  
MADE IN EUROPE

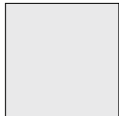

# COCOTTES

Finedining  
Porcelaine - Grès  
Porcelain - Stoneware

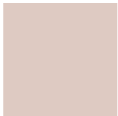

- |   |   |   |   |   |   |   |   |
|---|---|---|---|---|---|---|---|
|  |  |  |  |  |  |  |  |
| BLANC<br>WHITE<br>Porcelaine - Porcelain  | BLANC SABLE<br>SANDY WHITE<br>Porcelaine - Porcelain                                | ONYX<br>BLACK ONYX<br>Grès - Stoneware  | BLEU GOURMET<br>GOURMET BLUE<br>Grès - Stoneware                                    | ROSE NUDE<br>PINK NUDE<br>Grès - Stoneware  | DUNE<br>BEIGE DUNE<br>Grès - Stoneware  | BLEU DE ROCHE<br>BLUE STONE<br>Grès - Stoneware                                       | ARGILE VERTE<br>GREEN CLAY<br>Grès - Stoneware  |

BLANC  
WHITE  
Porcelaine - Porcelain

BLANC SABLE  
SANDY WHITE  
Porcelaine - Porcelain

ONYX  
BLACK ONYX  
Grés - Stoneware  
**NEW**

BLEU GOURMET  
GOURMET BLUE  
Grés - Stoneware

ROSE NUDE  
PINK NUDE  
Porcelaine - Porcelain

DUNE  
BEIGE DUNE  
Grés - Stoneware

BLEU DE ROCHE  
BLUE STONE  
Grés - Stoneware

ARGILE VERTE  
GREEN CLAY  
Grés - Stoneware

**ASSIETTE  
COCOTTE (1)**  
CASSEROLE  
PLATE  
22 CM - 8 IN<sup>15/16</sup>  
100 CL - 33 OZ<sup>15/16</sup>



234342

234345

243821

234339

**NEW**  
243815

**NEW**  
243818

**ASSIETTE  
COCOTTE (2)**  
CASSEROLE  
PLATE  
18 CM - 7 IN<sup>7/16</sup>  
70 CL - 23 OZ<sup>17/16</sup>



235064

235065

243830

235063

**NEW**  
243824

**NEW**  
243827

**BOL  
COCOTTE**  
ROUND  
CASSEROLE  
17,5 CM - 6 IN<sup>7/8</sup>  
140 CL - 47 OZ<sup>27/16</sup>



234341

234344

243803

234338

**NEW**  
243797

**NEW**  
243800

**BOL  
COCOTTE (3)**  
ROUND  
CASSEROLE  
14 CM - 5 IN<sup>1/2</sup>  
50 CL - 16 OZ<sup>15/16</sup>



209383

209720

236555

230821

243777

230927

230972

230958

**ASSIETTE  
COUVERCLE**  
ROUND  
PLATE/  
CASSEROLE  
LID  
12,5 CM - 4 IN<sup>15/16</sup>



209384

209384

236556

230820

243780

244137  
BI FINITION  
DUAL FINISH

230928

230973

230959

244138  
BI FINITION  
DUAL FINISH

**NEW**  
18 CM - 7 IN<sup>7/16</sup>



245378

245378

LIMITED STOCK

LIMITED STOCK

EMPILABLE - STACKABLE

**BOL BISEAUTÉ  
COCOTTE**  
SLANTED  
RIM BOWL  
16 CM - 6 IN<sup>5/16</sup>  
100 CL - 33 OZ<sup>15/16</sup>



234340

234343

234337

**BOL BISEAUTÉ  
COCOTTE(4)**  
SLANTED  
RIM BOWL  
12 CM - 4 IN<sup>3/4</sup>  
30 CL - 10 OZ<sup>1/8</sup>



186849

211893

236554

230822

243786

230926

230971

230957

**BOL BISEAUTÉ  
COCOTTE**  
SLANTED  
RIM BOWL  
7,3 CM - 2 IN<sup>7/8</sup>  
7 CL - 2 OZ<sup>3/8</sup>



211891

211892

236553

230823

243783

230925

230970

230956



(1) Compatible avec les assiettes de présentation  
Compatible with the presentation plates



(2) Compatible avec les assiettes plates 28 cm  
Compatible with the dinner plates 11 in



(3) Compatible avec les assiettes gourmet 30/32 cm  
Compatible with the round shallow bowls 11 in<sup>13/15</sup>/12 in<sup>5/8</sup>



(4) Compatible avec les assiettes gourmet 28/30 cm  
Compatible with the round shallow bowls 11 in/11 in<sup>15/16</sup>



SUPPORT 161036  
PLATEAU 30,5 X 10 CM  
TRAY STAND, 12 IN X 3 IN<sup>15/16</sup>  
3 PLACES



BLANC  
WHITE



DORÉ  
GOLD



**ASSIETTE PLATE 245447**

ROUND EXT : 32,5 CM - 12 IN<sup>13/16</sup>  
DINNER PLATE INT : 20 CM - 7 IN<sup>7/8</sup>  
W/WIDE RIM

**246109**

**245449**  
EXT : 28,5 CM - 11 IN<sup>1/4</sup>  
INT : 17 CM - 6 IN<sup>11/16</sup>

**246110**

**245451**  
EXT : 22,5 CM - 8 IN<sup>7/8</sup>  
INT : 15 CM - 5 IN<sup>7/8</sup>

**246111**



Compatible avec les assiettes cocottes  
Compatible with the casserole plates  
P 52-53

**CLOCHE VERRE BOROSILICATE**

DOME GLASS  
COVER **204043**  
17X9 CM  
6 IN<sup>11/16</sup> X 3 IN<sup>9/16</sup>

**BOUCHON PORCELAINE**

PORCELAIN LID  
**206504**  
5,2 CM - 2 IN<sup>1/16</sup>



Compatible avec les bols cocottes  
Compatible with the round casseroles  
P 52-53

**CLOCHE INOX**

DOME STAINLESS STEEL  
COVER **182614**  
24 CM - Ø 9 IN<sup>7/16</sup>

Compatible avec les bols biseautés cocottes  
Compatible with the slanted rim bowls  
P 52-53

**182301**  
14,8 CM - Ø 5 IN<sup>13/16</sup>

**ASSIETTE GOURMET 245457**

**OVALE GRAND BASSIN** EXT : 32 X 27 CM - 12 IN<sup>5/8</sup> X 10 IN<sup>5/8</sup>  
SHALLOW BOWL INT : 14,5 CM - 5 IN<sup>5/16</sup>  
W/WIDE OVAL RIM 27 CL - 9 OZ<sup>1/8</sup>

**246114**

**ASSIETTE GOURMET 245455**

**OVALE PETIT BASSIN** EXT : 30 X 26 CM - 11 IN<sup>3/16</sup> X 10 IN<sup>1/4</sup>  
SHALLOW BOWL INT : 13,5 CM - 5 IN<sup>5/16</sup>  
W/WIDE OVAL RIM 17 CL - 5 OZ<sup>3/4</sup>

**246113**



**ASSIETTE 245741**

**À PÂTES/SOUBE** EXT : 29,5 CM - 11 IN<sup>5/8</sup>  
ROUND SOUP/PASTA INT : 17 CM - 6 IN<sup>11/16</sup>  
BOWL W/WIDE RIM

**246115**

**ASSIETTE À PAIN 245453**

ROUND BREAD EXT : 15 CM - 9 IN<sup>1/16</sup>  
& BUTTER PLATE INT : 9,5 CM - 3 IN<sup>3/4</sup>  
W/WIDE RIM

**246112**



# GRAPHIQUE CLASSIQUE

Finedining  
Porcelaine  
Porcelain  
MADE IN EUROPE  
**NEW**



**ROND ROUND**



**ASSIETTE PLATE 207120**  
DINNER  
COUPE PLATE  
32 CM - 12 IN<sup>5/8</sup>

---

**207112**  
ROUND  
29 CM - 11 IN<sup>7/16</sup>

---

**207113**  
26 CM - 10 IN<sup>1/4</sup>

---

**207111**  
20 CM - 7 IN<sup>7/8</sup>

---

**207119**  
15 CM - 5 IN<sup>7/8</sup>



**ASSIETTE 207114**  
**CREUSE/**  
**CALOTTE**  
ROUND  
SHALLOW  
BOWL  
20 CM - 7 IN<sup>7/8</sup>



**BOL 142722**  
DEEP  
BOWL  
28 CM - 11 IN  
CONTENANCE : 2,5 L  
CAPACITY : 84 OZ<sup>9/16</sup>  
H : 12 CM - 4 IN<sup>3/4</sup>

**136529**  
24 CM - 9 IN<sup>7/16</sup>  
CONTENANCE : 2 L  
CAPACITY : 67 OZ<sup>5/8</sup>  
H : 11 CM - 4 IN<sup>1/4</sup>

**136511**  
20 CM - 7 IN<sup>7/8</sup>  
CONTENANCE : 1,30 L  
CAPACITY : 43 OZ<sup>15/16</sup>  
H : 9,5 CM - 3 IN<sup>3/4</sup>

**136528**  
16 CM - 6 IN<sup>5/16</sup>  
CONTENANCE : 67 CL  
CAPACITY : 22 OZ<sup>5/8</sup>  
H : 7,5 CM - 2 IN<sup>15/16</sup>

**154245**  
14 CM - 5 IN<sup>1/2</sup>  
CONTENANCE : 55 CL  
CAPACITY : 18 OZ<sup>5/8</sup>  
H : 8 CM - 2 IN<sup>1/16</sup>

**136510**  
12 CM - 4 IN<sup>3/4</sup>  
CONTENANCE : 27 CL  
CAPACITY : 9 OZ<sup>1/8</sup>  
H : 5,5 CM - 2 IN<sup>3/16</sup>



**COUPE 136535**  
SHALLOW  
BOWL,  
FOOTED  
24 CM - 9 IN<sup>7/16</sup>  
H : 11 CM - 4 IN<sup>1/4</sup>

**136530**  
8 CM - 3 IN<sup>1/8</sup>  
H : 2,5 CM - 1 IN



**ASSIETTE 246108**  
**COUPE** 24 CM - 9 IN<sup>7/16</sup>  
**RONDE**  
ROUND  
CEREAL  
PLATE

**ACCESSOIRES ACCESSORIES**



**PRÉSENTOIR 209382**  
**À GÂTEAUX**  
ROUND  
APP/PIZZA/  
PRESENTATION  
STAND  
32 CM - 12 IN<sup>5/8</sup>  
H : 10,5 CM - 4 IN<sup>1/4</sup>

---

**209381**  
25 CM - 9 IN<sup>13/16</sup>  
H : 8,5 CM - 2 IN<sup>3/16</sup>



**CLOCHE 239771**  
**EVENTO**  
Ø 28 CM - 11 IN  
**VERRE**  
**239770**  
EVENTO  
DOME  
COVER  
Ø 23 CM - 9 IN<sup>1/16</sup>

---

**239769**  
Ø 16 CM - 6 IN<sup>5/16</sup>



**PLAT À TARTE 136524**  
PIE/PIZZA  
PLATE,  
FLAT  
32 CM - 12 IN<sup>5/8</sup>



**COFFRET 182915**  
**SALIÈRE/**  
**POIVRIÈRE**  
SALT & PEPPER  
CRUET



**MODULO**

Alldaydining

Porcelaine  
Porcelain

MADE IN EUROPE



## CARRÉ SQUARE



**ASSIETTE PLATE** 207118  
SQUARE 28 CM - 11 IN  
COUPE PLATE

207115  
24 CM - 9 IN<sup>7/16</sup>

207117  
20 CM - 7 IN<sup>7/8</sup>

207123  
14 CM - 5 IN<sup>1/2</sup>



**COUPE** 136502  
SQUARE BOWL,  
FOOTED COUPE  
12 CM - 4 IN<sup>3/4</sup>  
H : 3,5 CM - 1 IN<sup>3/8</sup>

136503  
8 CM - 3 IN<sup>1/8</sup>  
H : 2,5 CM - 1 IN

## RECTANGLE RECTANGULAR



**ASSIETTE PLATE** 181485  
DINNER 34 X 26 CM  
COUPE PLATE 13 IN<sup>3/8</sup> X 10 IN<sup>1/4</sup>

207122  
30 X 22 CM  
11 IN<sup>13/16</sup> X 8 IN<sup>11/16</sup>

207110  
26 X 18 CM  
10 IN<sup>1/4</sup> X 7 IN<sup>1/16</sup>



**PLAT** 207754  
**RECTANGULAIRE** 40 X 16 CM  
RECTANGULAR DISH,  
COUPE LARGE 15 IN<sup>3/4</sup> X 6 IN<sup>5/16</sup>

207753  
20 X 12 CM  
7 IN<sup>7/8</sup> X 4 IN<sup>3/4</sup>



**SUPPORT** 161036  
**PLATEAU** 30,5 X 10 CM  
TRAY STAND,  
3 PLACES 12 IN X 3 IN<sup>15/16</sup>

## NEWCOOK MODULO



**RAMEQUIN** 162015  
RAMEKIN 9,5 CM - 3 IN<sup>3/4</sup>



**ASSIETTE** 162011  
**À CRÈME** 14 CM - 5 IN<sup>1/2</sup>  
**BRÛLÉE**  
«CRÈME BRÛLÉE»  
DISH



**PLAT** 164138  
**À ESCARGOTS** 16,6 X 11,2 CM -  
**6 PLACES** 6 IN<sup>9/16</sup> X 4 IN<sup>7/16</sup>  
SNAIL TRAY  
6 SPACES





# MODULO NATURE

Alldaydining  
Grès  
Stoneware



KAOLIN  
KAOLIN

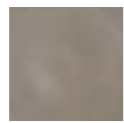

TERRE D'OMBRE  
TAUPE



PIERRE DE LAVE  
LAVA STONE



JADE  
GREEN JADE  
**NEW**

PIERRE DE LAVE  
LAVA STONE

KAOLIN  
KAOLIN

JADE  
JADE GREEN  
**NEW**

TERRE D'OMBRE  
TAUPE



**ASSIETTE** 194455  
**PLATE**  
31,5 CM - 12 IN<sup>3/8</sup>

ROUND  
DINNER PLATE

194454  
28 CM - 11 IN

194453  
21 CM - 8 IN<sup>1/4</sup>

230092  
16 CM - 6 IN<sup>5/16</sup>

184088  
31,5 CM - 12 IN<sup>3/8</sup>

184077  
28 CM - 11 IN

184078  
21 CM - 8 IN<sup>1/4</sup>

209092  
16 CM - 6 IN<sup>5/16</sup>

235681  
31,5 CM - 12 IN<sup>3/8</sup>

235682  
28 CM - 11 IN

235683  
21 CM - 8 IN<sup>1/4</sup>

235685  
16 CM - 6 IN<sup>5/16</sup>

184101  
31,5 CM - 12 IN<sup>3/8</sup>

184090  
28 CM - 11 IN

184091  
21 CM - 8 IN<sup>1/4</sup>

209093  
16 CM - 6 IN<sup>5/16</sup>



**ASSIETTE** 194452  
**CALOTTE**  
21 CM - 8 IN<sup>1/4</sup>

SALAD/  
CEREAL PLATE



184079  
21 CM - 8 IN<sup>1/4</sup>



235684  
21 CM - 8 IN<sup>1/4</sup>



184092  
21 CM - 8 IN<sup>1/4</sup>



**COUPE** 194457  
**CALOTTE**  
17,7 CM - 6 IN<sup>15/16</sup>  
SALAD/  
CEREAL PLATE  
DEEP  
H 5,5 CM - 2 IN<sup>3/16</sup>



184086  
17,7 CM - 6 IN<sup>15/16</sup>  
H 5,5 CM - 2 IN<sup>3/16</sup>



235687  
17,7 CM - 6 IN<sup>15/16</sup>  
H 5,5 CM - 2 IN<sup>3/16</sup>



184099  
17,7 CM - 6 IN<sup>15/16</sup>  
H 5,5 CM - 2 IN<sup>3/16</sup>



**COUPE RONDE** 234455  
**ROUND**  
25 CM - 9 IN<sup>13/16</sup>  
COUPE BOWL



234449  
25 CM - 9 IN<sup>13/16</sup>



235688  
25 CM - 9 IN<sup>13/16</sup>

Disponible 2ème trimestre  
Available second quarter



234451  
25 CM - 9 IN<sup>13/16</sup>

PIERRE DE LAVE  
LAVA STONE

KAOLIN  
KAOLIN

JADE  
JADE GREEN  
**NEW**

TERRE D'OMBRE  
TAUPE



**SALADIER** 194462  
**SALAD BOWL**  
24 CM - 9 IN<sup>7/16</sup>  
H 8 CM - 3 IN<sup>3/16</sup>



184087  
24 CM - 9 IN<sup>7/16</sup>  
H 8 CM - 3 IN<sup>3/16</sup>



235689  
24 CM - 9 IN<sup>7/16</sup>  
H 8 CM - 3 IN<sup>3/16</sup>



184100  
24 CM - 9 IN<sup>7/16</sup>  
H 8 CM - 3 IN<sup>3/16</sup>



**BOL À DÉJEUNER** 194456  
**SOUP/  
BREAKFAST BOWL**  
14 CM - 5 IN<sup>1/2</sup>  
58 CL - 19 OZ<sup>5/8</sup>



184084  
14 CM - 5 IN<sup>1/2</sup>  
58 CL - 19 OZ<sup>5/8</sup>



246064  
14 CM - 5 IN<sup>1/2</sup>  
58 CL - 19 OZ<sup>5/8</sup>  
Disponible 2ème trimestre  
Available second quarter



184097  
14 CM - 5 IN<sup>1/2</sup>  
58 CL - 19 OZ<sup>5/8</sup>



**COUPELLE** 194458  
**SMALL  
BOWL/CUP**  
10 CM - 3 IN<sup>15/16</sup>  
H 6 CM - 2 IN<sup>3/8</sup>



184085  
10 CM - 3 IN<sup>15/16</sup>  
H 6 CM - 2 IN<sup>3/8</sup>



235686  
10 CM - 3 IN<sup>15/16</sup>  
H 6 CM - 2 IN<sup>3/8</sup>



184098  
10 CM - 3 IN<sup>15/16</sup>  
H 6 CM - 2 IN<sup>3/8</sup>

### CAFÉTERIE COFFEEWARE



**TASSE À CAFÉ** 194459  
**DEMITASSE CUP**  
11,5 CL - 3 OZ<sup>7/8</sup>

**SOUCOUPE À CAFÉ** 194460  
**DEMITASSE SAUCER**  
12,5 CM - Ø 4 IN<sup>15/16</sup>



184081  
11,5 CL - 3 OZ<sup>7/8</sup>

184082  
12,5 CM - Ø 4 IN<sup>15/16</sup>



235690  
11,5 CL - 3 OZ<sup>7/8</sup>

235691  
12,5 CM - Ø 4 IN<sup>15/16</sup>



184094  
11,5 CL - 3 OZ<sup>7/8</sup>

184095  
12,5 CM - Ø 4 IN<sup>15/16</sup>

**TASSE À THÉ** 230093  
**TEA CUP**  
25 CL - 8 OZ<sup>7/16</sup>

**SOUCOUPE À THÉ** 230094  
**DEMITASSE/TEA SAUCER**  
15 CM - Ø 5 IN<sup>7/8</sup>

230163  
25 CL - 8 OZ<sup>7/16</sup>

230164  
15 CM - Ø 5 IN<sup>7/8</sup>

235692  
25 CL - 8 OZ<sup>7/16</sup>

235693  
15 CM - Ø 5 IN<sup>7/8</sup>

230165  
25 CL - 8 OZ<sup>7/16</sup>

230166  
15 CM - Ø 5 IN<sup>7/8</sup>



**MUG** 194461  
**MUG**  
33 CL - 11 OZ<sup>3/16</sup>



184083  
33 CL - 11 OZ<sup>3/16</sup>



184096  
33 CL - 11 OZ<sup>3/16</sup>



**ASSIETTE PLATE 243263**  
 DINNER 32 CM - 12 IN<sup>5/8</sup>  
 COUPE PLATE

---

**243265**  
 27,9 CM - 10 IN<sup>15/16</sup>

---

**243267**  
 24 CM - 9 IN<sup>7/16</sup>

**ASSIETTE 243271**  
**COUPE RONDE** 24 CM - 9 IN<sup>7/16</sup>  
 ROUND  
 CEREAL PLATE

---

**COUPELLE 243275**  
 RONDE 13 CM - 5 IN<sup>1/8</sup>



**BOL 243273**  
 DEEP 18 CM - 7 IN<sup>1/16</sup>  
 BOWL

**ASSIETTE À PAIN 243269**  
 ROUND 15 CM - 5 IN<sup>7/8</sup>  
 BREAD PLATE



**RIVAGE**

Alldaydining

Porcelaine  
 Porcelain

MADE IN EUROPE

**NEW**



L'abus d'alcool est dangereux pour la santé  
 Alcohol abuse is dangerous for your health



CAFÉTERIE  
TEATIME

Le thé et le café sont des univers où le plaisir des sens est décuplé par le plaisir esthétique. Pour rendre ces instants de dégustation uniques, DEGRENNE propose une large sélection de tasses et accessoires. Collection iconique de la marque depuis 1953, redécouvrez SALAM et réunissez tous les éléments pour maîtriser l'Art du Thé.

Drinking tea and coffee is a sensory delight heightened by the sheer aesthetic pleasure of the experience. DEGRENNE offers a wide range of cups and accessories to make tea and coffee drinking a unique experience. An iconic DEGRENNE collection since 1953 - why not seize the opportunity to rediscover SALAM and gather together the essentials needed to be skilled in the art of tea.

BLANCHE  
WHITE

Cloche inox miroir - Mirror stainless steel lid



**THÉIÈRE 211990**  
TEA POT  
8 TASSES - 8 CUPS  
130 CL - 43 OZ<sup>15/16</sup>

**211989**  
6 TASSES - 6 CUPS  
100 CL - 33 OZ<sup>13/16</sup>

**211988**  
4 TASSES - 4 CUPS  
70 CL - 23 OZ<sup>1/16</sup>

**211987**  
2 TASSES - 2 CUPS  
35 CL - 11 OZ<sup>13/16</sup>

NOIRE  
BLACK

Cloche inox brossée - Brushed stainless steel lid



**211994**  
8 TASSES - 8 CUPS  
130 CL - 43 OZ<sup>15/16</sup>

**211993**  
6 TASSES - 6 CUPS  
100 CL - 33 OZ<sup>13/16</sup>

**211992**  
4 TASSES - 4 CUPS  
70 CL - 23 OZ<sup>1/16</sup>

**211991**  
2 TASSES - 2 CUPS  
35 CL - 11 OZ<sup>13/16</sup>

NOIRE  
BLACK

Cloche aluminium noire mat - Black aluminium lid



**216414**  
6 TASSES - 6 CUPS  
100 CL - 33 OZ<sup>13/16</sup>

**216410**  
4 TASSES - 4 CUPS  
70 CL - 23 OZ<sup>1/16</sup>

**243214**  
2 TASSES - 2 CUPS  
35 CL - 11 OZ<sup>13/16</sup>

## ACCESSOIRES ACCESSORIES

BLANCHE  
WHITE



**CORPS 189949**  
**THÉIÈRE**  
TEA POT  
8 TASSES - 8 CUPS  
130 CL - 43 OZ<sup>15/16</sup>

**189948**  
6 TASSES - 6 CUPS  
100 CL - 33 OZ<sup>13/16</sup>

**189947**  
4 TASSES - 4 CUPS  
70 CL - 23 OZ<sup>1/16</sup>

**189946**  
2 TASSES - 2 CUPS  
35 CL - 11 OZ<sup>13/16</sup>



**BOUCHON 205136**  
**THÉIÈRE**  
TEA POT  
LID  
6/8 TASSES - 6/8 CUPS

**205135**  
2/4 TASSES - 2/4 CUPS



**SUCRIER 187276**  
SUGAR  
BOWL



**CRÉMIER 187277**  
CREAMER, JUG  
15 CL - 5 OZ<sup>1/16</sup>

NOIRE  
BLACK



**150447**  
8 TASSES - 8 CUPS  
130 CL - 43 OZ<sup>15/16</sup>

**150456**  
6 TASSES - 6 CUPS  
100 CL - 33 OZ<sup>13/16</sup>

**150455**  
4 TASSES - 4 CUPS  
70 CL - 23 OZ<sup>1/16</sup>

**150450**  
2 TASSES - 2 CUPS  
35 CL - 11 OZ<sup>13/16</sup>



**210576**  
6/8 TASSES - 6/8 CUPS

**210575**  
2/4 TASSES - 2/4 CUPS



**150475 150469**  
28 CL - 9 OZ<sup>7/16</sup>



**150485**  
15 CL - 5 OZ<sup>1/16</sup>



**FEUTRE 217133**  
**NOIR**  
**ISOLANT**  
BLACK  
TEA POT  
FELT  
8 TASSES - 8 CUPS

**217132**  
6 TASSES - 6 CUPS

**217131**  
4 TASSES - 4 CUPS

**217130**  
2 TASSES - 2 CUPS



**INFUSEUR 240331**  
STAINLESS  
STEEL  
FILTER  
6/8 TASSES - 6/8 CUPS

**240330**  
4 TASSES - 4 CUPS



# SALAM

Alldaydining

MADE IN FRANCE



ZINC  
BLANC - WHITE



**216416**  
6 TASSES - 6 CUPS  
100 CL - 33 OZ<sup>13/16</sup>

**216412**  
4 TASSES - 4 CUPS  
70 CL - 23 OZ<sup>1/16</sup>

BRONZE  
BLANC - WHITE



**216415**  
6 TASSES - 6 CUPS  
100 CL - 33 OZ<sup>13/16</sup>

**216411**  
4 TASSES - 4 CUPS  
70 CL - 23 OZ<sup>1/16</sup>

BRONZE  
NOIR - BLACK



**237415**  
6 TASSES - 6 CUPS  
100 CL - 33 OZ<sup>13/16</sup>

**237414**  
4 TASSES - 4 CUPS  
70 CL - 23 OZ<sup>1/16</sup>

BLEU - BLUE  
BLANC - WHITE



**225359**  
6 TASSES - 6 CUPS  
100 CL - 33 OZ<sup>13/16</sup>

**225358**  
4 TASSES - 4 CUPS  
70 CL - 23 OZ<sup>1/16</sup>

OR - GOLD  
BLANC - WHITE

Corps en porcelaine de Limoges  
Limoges porcelain body



**243794**  
4 TASSES - 4 CUPS  
70 CL - 23 OZ<sup>1/16</sup>

DORÉ - GOLDEN  
BLANC - WHITE



**234217**  
6 TASSES - 6 CUPS  
100 CL - 33 OZ<sup>13/16</sup>

**234216**  
4 TASSES - 4 CUPS  
70 CL - 23 OZ<sup>1/16</sup>

ROUGE(Pomme d'amour) - RED  
BLANC - WHITE



**238934**  
6 TASSES - 6 CUPS  
100 CL - 33 OZ<sup>13/16</sup>

ROUGE(Pomme d'amour) - RED  
NOIR - BLACK



**238935**  
6 TASSES - 6 CUPS  
100 CL - 33 OZ<sup>13/16</sup>

# SALAM

Alldaydining

MADE IN FRANCE



MONOCHROME BLANC  
MONOCHROME WHITE

Cloche inox blanche - White stainless steel lid



**242322**

6 TASSES - 6 CUPS  
100 CL - 33 OZ<sup>13/16</sup>

**242321**

4 TASSES - 4 CUPS  
70 CL - 23 OZ<sup>1/16</sup>

MONOCHROME BLEU GOURMET  
MONOCHROME GOURMET BLUE

Cloche inox bleue - Blue stainless steel lid



**242324**

6 TASSES - 6 CUPS  
100 CL - 33 OZ<sup>13/16</sup>

**242323**

4 TASSES - 4 CUPS  
70 CL - 23 OZ<sup>1/16</sup>

MONOCHROME ROSE NUDE  
MONOCHROME PINK NUDE

Cloche inox rose nude - Pink nude stainless steel lid



**242326**

6 TASSES - 6 CUPS  
100 CL - 33 OZ<sup>13/16</sup>

**242325**

4 TASSES - 4 CUPS  
70 CL - 23 OZ<sup>1/16</sup>

MONOCHROME VERT AMANDE  
MONOCHROME ALMOND GREEN

Cloche inox vert amande - Almond green stainless steel lid



**242328**

6 TASSES - 6 CUPS  
100 CL - 33 OZ<sup>13/16</sup>

**242327**

4 TASSES - 4 CUPS  
70 CL - 23 OZ<sup>1/16</sup>



# SALAM MONOCHROME

Alldaydining



MADE IN FRANCE



BLANC  
WHITE  
Porcelaine - Porcelain



**TASSE ESPRESSO 242636**  
ESPRESSO CUP 10 CL - 3 OZ<sup>3/8</sup>



**TASSE À THÉ 242628**  
**CAPPUCCINO** 25 CL - 8 OZ<sup>29/64</sup>  
TEA AND  
CAPPUCCINO CUP



**TASSE À DÉJEUNER 242620**  
BREAKFAST CUP 39 CL - 13 OZ<sup>3/16</sup>



**SOUCOUBE 242644**  
**CÉRAMIQUE** 15 CM - 5 IN<sup>7/8</sup>  
CERAMIC SAUCER

INOX  
STAINLESS STEEL



**SOUCOUBE 242652**  
**INOX** 15 CM - 5 IN<sup>7/8</sup>  
STAINLESS  
STEEL SAUCER

BLEU GOURMET  
GOURMET BLUE  
Grès - Stoneware



**242640**  
10 CL - 3 OZ<sup>3/8</sup>



**242632**  
25 CL - 8 OZ<sup>29/64</sup>



**242624**  
39 CL - 13 OZ<sup>3/16</sup>



**242648**  
15 CM - 5 IN<sup>7/8</sup>

ROSE NUDE  
PINK NUDE  
Grès - Stoneware



**242642**  
10 CL - 3 OZ<sup>3/8</sup>



**242634**  
25 CL - 8 OZ<sup>29/64</sup>



**242626**  
39 CL - 13 OZ<sup>3/16</sup>



**242650**  
15 CM - 5 IN<sup>7/8</sup>

VERT AMANDE  
ALMOND GREEN  
Grès - Stoneware



**242638**  
10 CL - 3 OZ<sup>3/8</sup>



**242630**  
25 CL - 8 OZ<sup>29/64</sup>



**242622**  
39 CL - 13 OZ<sup>3/16</sup>



**242646**  
15 CM - 5 IN<sup>7/8</sup>

# EMPILEO CAFETERIE

Alldaydining  
Céramique  
Ceramic







**TASSE À CAFÉ 210946**  
COFFEE/TEA POT 11 CL - 3 OZ<sup>3/4</sup>



**TASSE À THÉ 210947**  
COFFEE/TEA POT 25 CL - 8 OZ<sup>7/16</sup>



**TASSE À DÉJEUNER 210948**  
BREAKFAST CUP 42 CL - 14 OZ<sup>3/16</sup>



**MUG À THÉ 210949**  
TEA MUG 38 CL - 12 OZ<sup>7/8</sup>



**SOUCOUPE CAFÉ/THÉ 210950**  
DEMITASSE 16 CM - 6 IN<sup>5/16</sup>  
COFFEE/TEA SAUCER

**SOUCOUPE DÉJEUNER/ MUG 210951**  
BREAKFAST MUG 18 CM - 7 IN<sup>1/16</sup>  
SAUCER

# SALAM THÉ

Alldaydining  
Porcelaine  
Porcelain

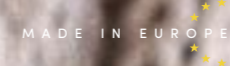

L



**TASSE ESPRESSO 227828**  
DEMITASSE CUP 10 CL - 3 OZ<sup>3/8</sup> - 5,7 CM - 2 IN<sup>1/4</sup>

**SOUCOUPE ESPRESSO 227831**  
DEMITASSE SAUCER 12,6 CM - Ø 4 IN<sup>15/16</sup>



**TASSE LUNGO 227829**  
COFFEE/TEA CUP 25 CL - 8 OZ<sup>7/16</sup> - 8,5 CM - 3 IN<sup>3/8</sup>

**SOUCOUPE LUNGO 227832**  
COFFEE/TEA SAUCER 15,8 CM - Ø 6 IN<sup>1/4</sup>

L COUTURE



**TASSE ESPRESSO 227828**  
DEMITASSE CUP 10 CL - 3 OZ<sup>3/8</sup> - 5,7 CM - 2 IN<sup>1/4</sup>

**SOUCOUPE ESPRESSO 237404**  
DEMITASSE SAUCER 12,6 CM - Ø 4 IN<sup>15/16</sup>



**TASSE LUNGO 227829**  
COFFEE/TEA CUP 25 CL - 8 OZ<sup>7/16</sup> - 8,5 CM - 3 IN<sup>3/8</sup>

**SOUCOUPE LUNGO 237405**  
COFFEE/TEA SAUCER 15,8 CM - Ø 6 IN<sup>1/4</sup>

L FRAGMENT



**TASSE ESPRESSO 227828**  
DEMITASSE CUP 10 CL - 3 OZ<sup>3/8</sup> - 5,7 CM - 2 IN<sup>1/4</sup>

**SOUCOUPE ESPRESSO 227849**  
DEMITASSE SAUCER 12,6 CM - Ø 4 IN<sup>15/16</sup>



**TASSE LUNGO 227829**  
COFFEE/TEA CUP 25 CL - 8 OZ<sup>7/16</sup> - 8,5 CM - 3 IN<sup>3/8</sup>

**SOUCOUPE LUNGO 227850**  
COFFEE/TEA SAUCER 15,8 CM - Ø 6 IN<sup>1/4</sup>

L PERLES DE ROSÉE

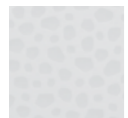

**TASSE ESPRESSO 227828**  
DEMITASSE CUP 10 CL - 3 OZ<sup>3/8</sup> - 5,7 CM - 2 IN<sup>1/4</sup>

**SOUCOUPE ESPRESSO 233928**  
DEMITASSE SAUCER 12,6 CM - Ø 4 IN<sup>15/16</sup>



**TASSE LUNGO 227829**  
COFFEE/TEA CUP 25 CL - 8 OZ<sup>7/16</sup> - 8,5 CM - 3 IN<sup>3/8</sup>

**SOUCOUPE LUNGO 233929**  
COFFEE/TEA SAUCER 15,8 CM - Ø 6 IN<sup>1/4</sup>

SD ONE



**TASSE ESPRESSO 242910**  
ESPRESSO CUP H 6,3 CM - 2 IN<sup>1/2</sup>  
Ø 6 CM - 2 IN<sup>3/8</sup>  
7 CL - 2 OZ<sup>3/8</sup>



**TASSE THÉ/CAFÉ 242912**  
TEA/COFFEE CUP H 8 CM - 3 IN<sup>1/8</sup>  
Ø 7,8 CM - 3 IN<sup>1/16</sup>  
15 CL - 5 OZ<sup>1/16</sup>

**SOUCOUPE 242914**  
SAUCER Ø 14 CM - 5 IN<sup>1/2</sup>



Finedining  
Haute Porcelaine de Limoges  
High Limoges Porcelain  
MADE IN FRANCE



## NEWPORT



**TASSE ESPRESSO** 207756  
DEMITASSE CUP 10 CL - 3 OZ<sup>3/8</sup>



**TASSE LUNGO** 207757  
COFFEE/TEA CUP 20 CL - 6 OZ<sup>3/4</sup>



**TASSE DÉJEUNER** 207758  
BREAKFAST CUP 40 CL - 13 OZ<sup>1/2</sup>

**SOUCOUBE ESPRESSO** 207759  
DEMITASSE SAUCER 12,5 CM - Ø 4 IN<sup>5/16</sup>

**SOUCOUBE LUNGO** 207760  
COFFEE/TEA SAUCER 15,8 CM - Ø 5 IN<sup>7/8</sup>

**SOUCOUBE DÉJEUNER** 207761  
BREAKFAST SAUCER 18 CM - 7 IN<sup>7/16</sup>



**VERSEUSE** 207764  
COFFEE/TEA POT 80 CL - 27 OZ<sup>1/16</sup>  
**207763**  
40 CL - 13 OZ<sup>1/2</sup>



**CRÉMIER** 207762  
CREAM JUG 10 CL - 3 OZ<sup>3/8</sup>



**COUVERCLES VERSEUSES** 210912  
LIDS FOR TEA POTS 8,4 CM - 3 IN<sup>5/16</sup>  
80 CL - 27 OZ<sup>1/16</sup>



**210911**  
6,6 CM - 2 IN<sup>5/8</sup>  
40 CL - 13 OZ<sup>1/2</sup>

## GRAPHIQUE CLASSIQUE BLANC

NEW



**TASSE ESPRESSO** 207756  
DEMITASSE CUP 10 CL - 3 OZ<sup>3/8</sup>



**TASSE LUNGO** 207757  
COFFEE/TEA CUP 20 CL - 6 OZ<sup>3/4</sup>



**TASSE DÉJEUNER** 207758  
BREAKFAST CUP 40 CL - 13 OZ<sup>1/2</sup>

**SOUCOUBE ESPRESSO** 246162  
DEMITASSE SAUCER 12,6 CM - Ø 4 IN<sup>5/16</sup>

**SOUCOUBE LUNGO** 246163  
COFFEE/TEA SAUCER 15 CM - Ø 5 IN<sup>7/8</sup>

**SOUCOUBE DÉJEUNER** 246268  
BREAKFAST SAUCER 18 CM - 7 IN<sup>7/16</sup>

## GRAPHIQUE CLASSIQUE DORÉ

NEW



**TASSE ESPRESSO** 207756  
DEMITASSE CUP 10 CL - 3 OZ<sup>3/8</sup>



**TASSE LUNGO** 207757  
COFFEE/TEA CUP 20 CL - 6 OZ<sup>3/4</sup>



**TASSE DÉJEUNER** 207758  
BREAKFAST CUP 40 CL - 13 OZ<sup>1/2</sup>

**SOUCOUBE ESPRESSO** 246164  
DEMITASSE SAUCER 12,6 CM - Ø 4 IN<sup>5/16</sup>

**SOUCOUBE LUNGO** 246165  
COFFEE/TEA SAUCER 15,8 CM - Ø 5 IN<sup>7/8</sup>

**SOUCOUBE DÉJEUNER** 246269  
BREAKFAST SAUCER 18 CM - 7 IN<sup>7/16</sup>

## BOREAL



**TASSE À CAFÉ** 186791  
DEMITASSE CUP 9 CL - 3 OZ<sup>1/16</sup>



**TASSE À THÉ** 186793  
COFFEE/TEA CUP 15 CL - 6 OZ<sup>3/4</sup>



**TASSE DÉJEUNER** 186795  
BREAKFAST CUP 40 CL - 13 OZ<sup>1/2</sup>

**SOUCOUBE À CAFÉ** 186792  
DEMITASSE SAUCER 14X12 CM  
Ø 5 IN<sup>1/2</sup> X 4 IN<sup>3/4</sup>

**SOUCOUBE À THÉ** 186794  
COFFEE/TEA SAUCER 16,5 X 14 CM  
Ø 6 IN<sup>1/2</sup> X 5 IN<sup>1/2</sup>

**SOUCOUBE DÉJEUNER** 186796  
BREAKFAST SAUCER 20X17 CM  
Ø 7 IN<sup>7/8</sup> X 6 IN<sup>11/16</sup>

## SMOOS



**SUPPORT** 161036  
**PLATEAU** 30,5 X 10 CM  
TRAY STAND, 12 IN X 3 IN<sup>15/16</sup>  
3 PLACES



Alldaydining

Porcelaine  
Porcelain

MADE IN EUROPE



PIERRE DE LAVE  
LAVA STONE

KAOLIN  
KAOLIN

TERRE D'OMBRE  
TAUPE

JADE  
JADE GREEN  
**NEW**



**TASSE À CAFÉ** 194459  
DEMITASSE CUP 11,5 CL - 3 OZ<sup>7/8</sup>

**SOUCOUBE À CAFÉ** 194460  
DEMITASSE SAUCER 12,5 CM - Ø 4 IN<sup>15/16</sup>

**TASSE À THÉ** 230093  
TEA CUP 25 CL - 8 OZ<sup>7/16</sup>

**SOUCOUBE À THÉ** 230094  
DEMITASSE/TEA SAUCER 15 CM - Ø 5 IN<sup>7/8</sup>



**184081**  
11,5 CL - 3 OZ<sup>7/8</sup>

**184082**  
12,5 CM - Ø 4 IN<sup>15/16</sup>

**230163**  
25 CL - 8 OZ<sup>7/16</sup>

**230164**  
15 CM - Ø 5 IN<sup>7/8</sup>



**184094**  
11,5 CL - 3 OZ<sup>7/8</sup>

**184095**  
12,5 CM - Ø 4 IN<sup>15/16</sup>

**230165**  
25 CL - 8 OZ<sup>7/16</sup>

**230166**  
15 CM - Ø 5 IN<sup>7/8</sup>



**235690**  
11,5 CL - 3 OZ<sup>7/8</sup>

**235691**  
12,5 CM - Ø 4 IN<sup>15/16</sup>

**235692**  
25 CL - 8 OZ<sup>7/16</sup>

**235693**  
15 CM - Ø 5 IN<sup>7/8</sup>



**MUG** 194461  
MUG 33 CL - 11 OZ<sup>3/16</sup>



**184083**  
33 CL - 11 OZ<sup>3/16</sup>



**184096**  
33 CL - 11 OZ<sup>3/16</sup>



# MODULO NATURE

Alldaydining  
Grès  
Stoneware





# LES COUVERTS FLATWARE

Les ateliers DEGRENNE donnent forme aux majestueuses bobines d'acier inoxydable et transforment la matière brute en couverts. Les couverts DEGRENNE bénéficient d'un savoir-faire unique et se caractérisent par une ergonomie et une résistance exceptionnelle.

Faciles d'entretien, ils répondent aux critères les plus exigeants de qualité, de fonctionnalité et d'esthétique. La qualité du design et le soin apporté aux finitions font de chacun de nos couverts de véritables pièces d'orfèvre de style classique ou contemporain. Créé en collaboration avec des chefs ou en laissant libre cours à l'imagination de nos designers, aux lignes sobres ou plus élaborées, chaque modèle DEGRENNE trouve sa place à table.

DEGRENNE'S workshops shape the impressive reels of stainless steel and transform the raw material into cutlery. We use our unique expertise to create our cutlery, which is characterized by being extraordinarily easy to use and sturdy. DEGRENNE cutlery is easy to look after and meets the most stringent quality, functionality and appearance criteria. The design quality and painstaking finishes make each of our items of cutlery true pieces of classic or contemporary silverware. DEGRENNE cutlery is designed in partnership with chefs or by giving our designers free rein. Some items have simple lines, while others are more elaborate, but every DEGRENNE design takes pride of place on a table.

Découvrez les coulisses de notre  
manufacture à Vire

Discover our factory in Vire





LES  
COUVERTS  
DESIGN  
DESIGN FLATWARE

# AQUATIC

Alldaydining

MADE IN FRANCE



**126355**  
**FOURCHETTE DE TABLE**  
TABLE FORK  
20,1 CM - 7 IN<sup>5/16</sup>



**126358**  
**CUILLÈRE À CAFÉ**  
COFFEE/TEA SPOON  
13,7 CM - 5 IN<sup>1/8</sup>



**210731**  
**COUTEAU DE TABLE**  
**MONOBLOC LAME SCIE**  
TABLE KNIFE SOLID HANDLE SERRATED  
23,5 CM - 9 IN<sup>1/4</sup>



**140852**  
**CUILLÈRE À MOKA**  
DEMI TASSE SPOON  
11 CM - 4 IN<sup>5/16</sup>



**126352**  
**CUILLÈRE DE TABLE**  
TABLE/PASTA SPOON  
20,3 CM - 8 IN



**189973**  
**CUILLÈRE À SODA**  
ICED TEA SPOON  
19 CM - 7 IN<sup>1/2</sup>



**140855**  
**CUILLÈRE À SOUPE ANGLAISE**  
BOUILLON SPOON, ROUND  
17,9 CM - 7 IN<sup>7/16</sup>



**126383**  
**FOURCHETTE À GÂTEAUX**  
**COCKTAIL**  
PASTRY/COCKTAIL FORK  
13,7 CM - 5 IN<sup>5/8</sup>



**126368**  
**CUILLÈRE À DESSERT**  
DESSERT/SOUP SPOON, OVAL  
17,8 CM - 7 IN



**189974**  
**FOURCHETTE À HÙÎTRES**  
OYSTER FORK  
14,1 CM - 5 IN<sup>3/16</sup>



**126371**  
**FOURCHETTE À DESSERT**  
DESSERT/SALAD FORK  
17,7 CM - 6 IN<sup>5/16</sup>



**231218**  
**FOURCHETTE DE SERVICE**  
SERVING FORK  
26,6 CM - 10 IN<sup>1/2</sup>



**210732**  
**COUTEAU À DESSERT**  
**MONOBLOC LAME UNIE**  
DESSERT KNIFE SOLID HANDLE  
20,7 CM - 8 IN<sup>1/8</sup>



**231219**  
**CUILLÈRE DE SERVICE**  
SERVING SPOON  
26,6 CM - 10 IN<sup>1/2</sup>



**189971**  
**COUTEAU À BEURRE**  
**MONOBLOC LAME UNIE**  
BUTTER KNIFE SOLID HANDLE  
18,9 CM - 7 IN<sup>7/16</sup>



**231221**  
**PELLE À TARTE MONOBLOC**  
PASTRY SERVER SOLID HANDLE  
25,2 CM - 9 IN<sup>15/16</sup>



**126377**  
**FOURCHETTE À POISSON**  
FISH FORK  
17,7 CM - 6 IN<sup>5/16</sup>



**231220**  
**LOUCHE**  
SOUP LADLE  
29 CM - 11 IN<sup>7/16</sup>



**181181**  
**COUTEAU À POISSON/**  
**GOURMET**  
GOURMET FISH KNIFE  
20,1 CM - 7 IN<sup>5/16</sup>

EGALEMENT DISPONIBLE EN MÉTAL ARGENTÉ  
ALSO AVAILABLE IN SILVERPLATED FINISH



Disponible sur commande  
Available on request

Possibilité de personnalisation  
Bespoke options available

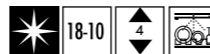

# COUTURE

Alldaydining

MADE IN FRANCE



**239410**  
**FOURCHETTE DE TABLE**  
TABLE FORK  
20,1 CM - 7 IN<sup>5/16</sup>



**239411**  
**COUTEAU DE TABLE**  
**MANCHE ORFÈVRE LAME UNIE**  
HOLLOW HANDLE TABLE KNIFE  
23,5 CM - 9 IN<sup>1/4</sup>



**239412**  
**CUILLÈRE DE TABLE**  
TABLE/PASTA SPOON  
20,3 CM - 8 IN



**239416**  
**CUILLÈRE À DESSERT**  
DESSERT/SOUP SPOON, OVAL  
17,8 CM - 7 IN



**239414**  
**FOURCHETTE À DESSERT**  
DESSERT/SALAD FORK  
17,7 CM - 6 IN<sup>5/16</sup>



**239415**  
**COUTEAU À DESSERT**  
**MANCHE ORFÈVRE LAME UNIE**  
DESSERT KNIFE HOLLOW HANDLE  
21,1 CM - 8 IN<sup>5/16</sup>



**239418**  
**FOURCHETTE À POISSON**  
FISH FORK  
17,7 CM - 6 IN<sup>5/16</sup>



**239419**  
**COUTEAU À POISSON/**  
**GOURMET**  
GOURMET FISH KNIFE  
20,1 CM - 7 IN<sup>5/16</sup>



**239413**  
**CUILLÈRE À CAFÉ**  
COFFEE/TEA SPOON  
13,7 CM - 5 IN<sup>3/8</sup>



**239417**  
**CUILLÈRE À MOKA**  
COFFEE/TEA SPOON  
11 CM - 4 IN<sup>5/16</sup>



EGALEMENT DISPONIBLE EN MÉTAL ARGENTÉ  
ALSO AVAILABLE IN SILVERPLATED FINISH

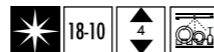



# SUPERNATURE

Alldaydining

MADE IN FRANCE



**242668**  
**FOURCHETTE DE TABLE**  
TABLE FORK  
20,1 CM - 7 IN<sup>5/16</sup>



**242674**  
**COUTEAU DE TABLE**  
**MONOBLOC LAME SCIE**  
SOLID HANDLE TABLE KNIFE SERRATED  
23,5 CM - 9 IN<sup>3/4</sup>



**242665**  
**CUILLÈRE DE TABLE**  
TABLE/PASTA SPOON  
20,3 CM - 8 IN



**242689**  
**CUILLÈRE À SOUPE ANGLAISE**  
BOUILLON SPOON, ROUND  
17,9 CM - 7 IN<sup>7/16</sup>



**242677**  
**CUILLÈRE À DESSERT**  
DESSERT/SOUP SPOON, OVAL  
17,8 CM - 7 IN



**242680**  
**FOURCHETTE À DESSERT**  
DESSERT/SALAD FORK  
17,7 CM - 6 IN<sup>5/16</sup>



**242683**  
**COUTEAU À DESSERT**  
**MONOBLOC LAME UNIE**  
DESSERT KNIFE SOLID HANDLE  
20,7 CM - 8 IN<sup>1/8</sup>



**242705**  
**COUTEAU À BEURRE MONOBLOC**  
BUTTER KNIFE SOLID HANDLE  
18,9 CM - 7 IN<sup>7/16</sup>



**242671**  
**CUILLÈRE À CAFÉ**  
COFFEE/TEA SPOON  
13,7 CM - 5 IN<sup>3/8</sup>



**242686**  
**CUILLÈRE À MOKA**  
COFFEE/TEA SPOON  
11 CM - 4 IN<sup>5/16</sup>

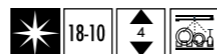

# ASTRÉE CISELÉ

Alldaydining



**153998**  
**FOURCHETTE DE TABLE**  
TABLE FORK  
20,7 CM - 8 IN<sup>1/8</sup>



**154002**  
**COUTEAU DE TABLE**  
**MONOBLOC LAME SCIE**  
TABLE KNIFE SOLID HANDLE SERRATED  
23,5 CM - 9 IN<sup>1/4</sup>



**199761**  
**COUTEAU À STEAK**  
STEAK TABLE  
22,8 CM - 9 IN



**153996**  
**CUILLÈRE DE TABLE**  
TABLE/PASTA SPOON  
20,7 CM - 8 IN<sup>1/8</sup>



**154577**  
**CUILLÈRE À MOKA**  
DEMI TASSE SPOON  
11,1 CM - 4 IN<sup>1/8</sup>



**190016**  
**CUILLÈRE À SODA**  
ICED TEA SPOON  
19 CM - 7 IN<sup>1/2</sup>



**154547**  
**FOURCHETTE À GÂTEAUX**  
**COCKTAIL**  
PASTRY/COCKTAIL FORK  
13,9 CM - 5 IN<sup>1/2</sup>



**154563**  
**FOURCHETTE DE SERVICE**  
SERVING FORK  
26,6 CM - 10 IN<sup>1/2</sup>



**190015**  
**CUILLÈRE À SOUPE ANGLAISE**  
BOUILLON SPOON, ROUND  
18,3 CM - 7 IN<sup>3/16</sup>

**154562**  
**CUILLÈRE DE SERVICE**  
SERVING SPOON  
27 CM - 10 IN<sup>5/8</sup>



**154571**  
**CUILLÈRE À DESSERT**  
DESSERT/SOUP SPOON, OVAL  
18,6 CM - 7 IN<sup>5/16</sup>

**154566**  
**SERVICE À SALADE**  
SALAD SERVING SET  
30 CM - 11 IN<sup>3/16</sup>



**154574**  
**FOURCHETTE À DESSERT**  
DESSERT/SALAD FORK  
18,6 CM - 7 IN<sup>5/16</sup>

**154552**  
**PELLE À TARTE MONOBLOC**  
PASTRY SERVER SOLID HANDLE  
25,1 CM - 9 IN<sup>7/8</sup>



**154555**  
**COUTEAU À DESSERT**  
**MONOBLOC LAME SCIE**  
DESSERT KNIFE SOLID HANDLE  
SERRATED  
21,1 CM - 8 IN<sup>3/8</sup>

**154550**  
**LOUCHE**  
SOUP LADLE  
29,7 CM - 11 IN<sup>1/8</sup>



**154580**  
**COUTEAU À BEURRE**  
**MONOBLOC LAME UNIE**  
BUTTER KNIFE SOLID HANDLE  
19,4 CM - 7 IN<sup>5/8</sup>



**154558**  
**FOURCHETTE À POISSON**  
FISH FORK  
18,6 CM - 7 IN<sup>5/16</sup>





**154561**  
**COUTEAU À POISSON/**  
**GOURMET**  
GOURMET FISH KNIFE  
21,1 CM - 8 IN<sup>3/16</sup>



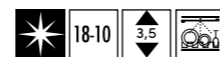

**154001**  
**CUILLÈRE À CAFÉ**  
COFFEE/TEA SPOON  
14,1 CM - 5 IN<sup>9/16</sup>





- 

**236700**  
**FOURCHETTE DE TABLE**  
TABLE FORK  
21,5 CM - 8 IN<sup>7/16</sup>
- 

**236702**  
**COUTEAU DE TABLE**  
**MONOBLOC LAME SCIE**  
TABLE KNIFE SOLID HANDLE SERRATED  
21,5 CM - 8 IN<sup>7/16</sup>
- 

**111970**  
**COUTEAU DE TABLE**  
**MONOBLOC LAME SCIE**  
TABLE KNIFE SOLID HANDLE SERRATED  
23 CM - 9 IN<sup>1/8</sup>
- 

**236701**  
**CUILLÈRE DE TABLE**  
TABLE/PASTA SPOON  
21,5 CM - 8 IN<sup>7/16</sup>
- 

**236726**  
**CUILLÈRE À SOUPE ANGLAISE**  
BOUILLON SPOON, ROUND  
18,5 CM - 7 IN<sup>5/16</sup>
- 

**236721**  
**CUILLÈRE À DESSERT**  
DESSERT/SOUP SPOON, OVAL  
19,1 CM - 7 IN<sup>1/2</sup>
- 

**236719**  
**FOURCHETTE À DESSERT**  
DESSERT/SALAD FORK  
19,1 CM - 7 IN<sup>1/2</sup>
- 

**236720**  
**COUTEAU À DESSERT**  
**MONOBLOC LAME UNIE**  
DESSERT KNIFE SOLID HANDLE  
19,2 CM - 7 IN<sup>7/16</sup>
- 

**236727**  
**TARTINEUR**  
BUTTER SPREADER  
16,5 CM - 6 IN<sup>1/2</sup>
- 

**181112**  
**TARTINEUR**  
BUTTER SPREADER  
16 CM - 6 IN<sup>5/16</sup>
- 

**236703**  
**CUILLÈRE À CAFÉ**  
COFFEE/TEA SPOON  
15 CM - 5 IN<sup>7/8</sup>
- 

**236722**  
**CUILLÈRE À MOKA**  
DEMI TASSE SPOON  
11 CM - 4 IN<sup>5/16</sup>
- 

**236724**  
**FOURCHETTE DE SERVICE**  
SERVING FORK  
26 CM - 10 IN<sup>1/4</sup>
- 

**236723**  
**CUILLÈRE DE SERVICE**  
SERVING SPOON  
26 CM - 10 IN<sup>1/4</sup>

EGALEMENT DISPONIBLE EN MÉTAL ARGENTÉ  
ALSO AVAILABLE IN SILVERPLATED FINISH



Possibilité de personnalisation  
Bespoke options available

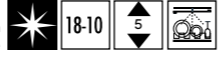

# FUSE MIROIR

Finedining



FUSE MARTELÉ HAMMERED

- 

**236790**  
**FOURCHETTE DE TABLE**  
TABLE FORK  
21,5 CM - 8 IN<sup>37/16</sup>
- 

**236791**  
**COUTEAU DE TABLE**  
**MONOBLOC LAME SCIE**  
TABLE KNIFE SOLID HANDLE SERRATED  
21,5 CM - 8 IN<sup>37/16</sup>
- 

**236789**  
**CUILLÈRE DE TABLE**  
TABLE/PASTA SPOON  
21,5 CM - 8 IN<sup>37/16</sup>
- 

**236802**  
**CUILLÈRE À SOUPE ANGLAISE**  
BOUILLON SPOON, ROUND  
18,5 CM - 7 IN<sup>37/16</sup>
- 

**236796**  
**CUILLÈRE À DESSERT**  
DESSERT/SOUP SPOON, OVAL  
19,1 CM - 7 IN<sup>1/2</sup>
- 

**236794**  
**FOURCHETTE À DESSERT**  
DESSERT/SALAD FORK  
19,1 CM - 7 IN<sup>1/2</sup>
- 

**236795**  
**COUTEAU À DESSERT**  
**MONOBLOC LAME UNIE**  
DESSERT KNIFE SOLID HANDLE  
19,2 CM - 7 IN<sup>37/16</sup>
- 

**236804**  
**TARTINEUR**  
BUTTER SPREADER  
16,5 CM - 6 IN<sup>1/2</sup>
- 

**236798**  
**CUILLÈRE À CAFÉ**  
COFFEE/TEA SPOON  
15 CM - 5 IN<sup>7/8</sup>
- 

**236797**  
**CUILLÈRE À MOKA**  
DEMI TASSE SPOON  
11 CM - 4 IN<sup>5/16</sup>
- 

**236806**  
**PIC APÉRO**  
COCKTAIL PICK  
15 CM - 5 IN<sup>7/8</sup>
- 

**236805**  
**FOURCHETTE/PIQUE À**  
**ESCARGOTS/COCKTAIL**  
COCKTAIL, SNAIL FORK  
15 CM - 5 IN<sup>7/8</sup>
- 

**236800**  
**FOURCHETTE DE SERVICE**  
SERVING FORK  
26 CM - 10 IN<sup>1/4</sup>
- 

**236799**  
**CUILLÈRE DE SERVICE**  
SERVING SPOON  
26 CM - 10 IN<sup>1/4</sup>

Possibilité de personnalisation  
Bespoke options available



























# FUSE MARTELÉ

Finedining



# GUEST MIROIR

Finedining

- |   |   |  |  |
|---|---|--|--|
|     | <b>197507</b><br><b>FOURCHETTE DE TABLE</b><br>TABLE FORK<br>21,3 CM - 8 IN <sup>5/16</sup>   |    | <b>197515</b><br><b>COUTEAU À POISSON/GOURMET</b><br>GOURMET FISH KNIFE<br>21,3 CM - 8 IN <sup>5/16</sup>      |
|     | <b>197509</b><br><b>COUTEAU DE TABLE MONOBLOC LAME SCIE</b><br>TABLE KNIFE SOLID HANDLE SERRATED<br>23,2 CM - 9 IN <sup>1/16</sup>    |    | <b>197508</b><br><b>CUILLÈRE À CAFÉ</b><br>COFFEE/TEA SPOON<br>14,3 CM - 5 IN <sup>5/16</sup>                  |
|     | <b>235481</b><br><b>COUTEAU DE TABLE MONOBLOC LAME SCIE</b><br>TABLE KNIFE SOLID HANDLE SERRATED<br>23,7 CM - 9 IN <sup>5/16</sup>    |    | <b>197510</b><br><b>CUILLÈRE À MOKA</b><br>DEMITASSE SPOON<br>11,7 CM - 4 IN <sup>5/16</sup>                   |
|     | <b>197521</b><br><b>COUTEAU À STEAK MONOBLOC LAME SCIE</b><br>STEAK KNIFE SOLID HANDLE SERRATED<br>23,2 CM - 9 IN <sup>1/16</sup>     |    | <b>190018</b><br><b>CUILLÈRE À SODA</b><br>ICED TEA SPOON<br>19 CM - 7 IN <sup>1/2</sup>                       |
|     | <b>197506</b><br><b>CUILLÈRE DE TABLE</b><br>TABLE/PASTA SPOON<br>21,6 CM - 8 IN <sup>1/2</sup>                                       |    | <b>197516</b><br><b>FOURCHETTE À GÂTEAUX/COCKTAIL</b><br>PASTRY/COCKTAIL FORK<br>13,9 CM - 5 IN <sup>1/2</sup> |
|    | <b>197518</b><br><b>CUILLÈRE À SOUPE ANGLAISE</b><br>BOUILLON SPOON, ROUND<br>18,5 CM - 7 IN <sup>5/16</sup>                          |    | <b>190424</b><br><b>FOURCHETTE À HUÎTRES</b><br>OYSTER FORK<br>14,1 CM - 5 IN <sup>9/16</sup>                  |
|    | <b>197512</b><br><b>CUILLÈRE À DESSERT</b><br>DESSERT/SOUP SPOON, OVAL<br>19,5 CM - 7 IN <sup>11/16</sup>                             |    | <b>197522</b><br><b>FOURCHETTE DE SERVICE</b><br>SERVING FORK<br>26,6 CM - 10 IN <sup>1/2</sup>                |
|  | <b>197511</b><br><b>FOURCHETTE À DESSERT</b><br>DESSERT/SALAD FORK<br>19,2 CM - 7 IN <sup>9/16</sup>                                  |  | <b>197523</b><br><b>CUILLÈRE DE SERVICE</b><br>SERVING SPOON<br>27 CM - 10 IN <sup>5/16</sup>                  |
|  | <b>210629</b><br><b>COUTEAU À DESSERT MONOBLOC LAME SCIE</b><br>DESSERT KNIFE SOLID HANDLE SERRATED<br>20,9 CM - 8 IN <sup>3/16</sup> |  | <b>197525</b><br><b>SERVICE À SALADE</b><br>SALAD SERVING SET<br>30 CM - 11 IN <sup>13/16</sup>                |
|   | <b>235482</b><br><b>COUTEAU À DESSERT MONOBLOC LAME UNIE</b><br>DESSERT KNIFE SOLID HANDLE<br>21,3 CM - 8 IN <sup>3/16</sup>          |  | <b>197527</b><br><b>PELLE À TARTE MONOBLOC</b><br>PASTRY SERVER SOLID HANDLE<br>25,1 CM - 9 IN <sup>7/16</sup> |
|  | <b>197520</b><br><b>COUTEAU À BEURRE MONOBLOC LAME UNIE</b><br>BUTTER KNIFE SOLID HANDLE<br>19,3 CM - 7 IN <sup>5/16</sup>            |  | <b>153193</b><br><b>LOUCHE</b><br>SOUP LADLE<br>29,7 CM - 11 IN <sup>11/16</sup>                               |
|  | <b>181112</b><br><b>TARTINEUR</b><br>BUTTER SPREADER<br>16 CM - 6 IN <sup>5/16</sup>  |  | <b>154606</b><br><b>CUILLÈRE À SAUCE</b><br>SAUCE LADLE<br>18,5 CM - 7 IN <sup>5/16</sup>                      |
|  | <b>197514</b><br><b>FOURCHETTE À POISSON</b><br>FISH FORK<br>19,2 CM - 7 IN <sup>9/16</sup>   |  |  |

EGALEMENT DISPONIBLE EN MÉTAL ARGENTÉ  
ALSO AVAILABLE IN SILVERPLATED FINISH



Possibilité de personnalisation  
Bespoke options available

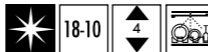

©Patrick ROUGEREAU  
L'abus d'alcool est dangereux pour la santé  
Alcohol abuse is dangerous for your health

# GUEST CUIVRE

Finedining

## GUEST CUIVRE COPPER



**230848**  
**FOURCHETTE DE TABLE**  
TABLE FORK  
21,3 CM - 8 IN<sup>3/8</sup>



**230850**  
**COUTEAU DE TABLE**  
**MONOBLOC LAME SCIE**  
TABLE KNIFE SOLID HANDLE SERRATED  
23,2 CM - 9 IN<sup>1/8</sup>



**230849**  
**CUILLÈRE DE TABLE**  
TABLE/PASTA SPOON  
21,6 CM - 8 IN<sup>1/2</sup>



**230854**  
**CUILLÈRE À DESSERT**  
DESSERT/SOUP SPOON, OVAL  
19,5 CM - 7 IN<sup>11/16</sup>



**230853**  
**FOURCHETTE À DESSERT**  
DESSERT/SALAD FORK  
19,2 CM - 7 IN<sup>9/16</sup>



**230855**  
**COUTEAU À DESSERT**  
**MONOBLOC LAME SCIE**  
DESSERT KNIFE SOLID HANDLE  
SERRATED  
20,9 CM - 8 IN<sup>3/16</sup>



**230851**  
**CUILLÈRE À CAFÉ**  
COFFEE/TEA SPOON  
14,3 CM - 5 IN<sup>5/8</sup>



**230852**  
**CUILLÈRE À MOKA**  
DEMI TASSE SPOON  
11,7 CM - 4 IN<sup>5/16</sup>



Possibilité de personnalisation  
Bespoke options available





**223482**  
**FOURCHETTE DE TABLE**  
TABLE FORK  
21,3 CM - 8 IN<sup>3/8</sup>



**202995**  
**COUTEAU DE TABLE**  
**MONOBLOC LAME SCIE**  
TABLE KNIFE SOLID HANDLE SERRATED  
23,2 CM - 9 IN<sup>1/8</sup>



**203017**  
**COUTEAU À STEAK**  
**MONOBLOC LAME SCIE**  
STEAK KNIFE SOLID HANDLE SERRATED  
23,2 CM - 9 IN<sup>1/8</sup>



**223481**  
**CUILLÈRE DE TABLE**  
TABLE/PASTA SPOON  
21,6 CM - 8 IN<sup>1/2</sup>



**223491**  
**CUILLÈRE À SOUPE ANGLAISE**  
BOUILLON SPOON, ROUND  
18,5 CM - 7 IN<sup>5/16</sup>



**223486**  
**CUILLÈRE À DESSERT**  
DESSERT/SOUP SPOON, OVAL  
19,5 CM - 7 IN<sup>11/16</sup>



**223485**  
**FOURCHETTE À DESSERT**  
DESSERT/SALAD FORK  
19,2 CM - 7 IN<sup>9/16</sup>



**210630**  
**COUTEAU À DESSERT**  
**MONOBLOC LAME SCIE**  
DESSERT KNIFE SOLID HANDLE  
SERRATED  
20,9 CM - 8 IN<sup>3/16</sup>



**203016**  
**COUTEAU À BEURRE**  
**MONOBLOC LAME UNIE**  
BUTTER KNIFE SOLID HANDLE  
19,3 CM - 7 IN<sup>5/8</sup>



**223487**  
**FOURCHETTE À POISSON**  
FISH FORK  
19,2 CM - 7 IN<sup>9/16</sup>



**223488**  
**COUTEAU À POISSON/GOURMET**  
GOURMET FISH KNIFE  
21,3 CM - 8 IN<sup>3/8</sup>



**223483**  
**CUILLÈRE À CAFÉ**  
COFFEE/TEA SPOON  
14,3 CM - 5 IN<sup>5/8</sup>



**223484**  
**CUILLÈRE À MOKA**  
DEMI TASSE SPOON  
11,7 CM - 4 IN<sup>5/8</sup>



**223492**  
**CUILLÈRE À SODA**  
ICED TEA SPOON  
18,9 CM - 7 IN<sup>7/16</sup>



**223489**  
**FOURCHETTE À GÂTEAUX/COCKTAIL**  
PASTRY/COCKTAIL FORK  
13,9 CM - 5 IN<sup>1/2</sup>



**223493**  
**FOURCHETTE DE SERVICE**  
SERVING FORK  
26,6 CM - 10 IN<sup>1/2</sup>



**223494**  
**CUILLÈRE DE SERVICE**  
SERVING SPOON  
27 CM - 10 IN<sup>5/8</sup>



**223497**  
**PELLE À TARTE MONOBLOC**  
PASTRY SERVER SOLID HANDLE  
25,1 CM - 9 IN<sup>7/8</sup>



# GUEST VINTAGE

Finedining



**217139**  
**FOURCHETTE DE TABLE**  
TABLE FORK  
21,3 CM - 8 IN<sup>3/8</sup>



**217140**  
**COUTEAU DE TABLE**  
**MONOBLOC LAME SCIE**  
TABLE KNIFE SOLID HANDLE SERRATED  
23,2 CM - 9 IN<sup>1/8</sup>



**230339**  
**COUTEAU À STEAK**  
**MONOBLOC LAME SCIE**  
STEAK KNIFE SOLID HANDLE SERRATED  
23,2 CM - 9 IN<sup>1/8</sup>



**246255**  
**COUTEAU DE TABLE**  
**DROIT LAME SCIE**  
TABLE KNIFE SOLID HANDLE SERRATED  
23,2 CM - 9 IN<sup>1/8</sup>



**217141**  
**CUILLÈRE DE TABLE**  
TABLE/PASTA SPOON  
21,6 CM - 8 IN<sup>1/2</sup>



**217143**  
**CUILLÈRE À DESSERT**  
DESSERT/SOUP SPOON, OVAL  
19,5 CM - 7 IN<sup>1/8</sup>



**217144**  
**FOURCHETTE À DESSERT**  
DESSERT/SALAD FORK  
19,2 CM - 7 IN<sup>9/16</sup>



**217145**  
**COUTEAU À DESSERT**  
**MONOBLOC LAME SCIE**  
DESSERT KNIFE SOLID HANDLE  
SERRATED  
20,9 CM - 8 IN<sup>3/16</sup>



**246257**  
**COUTEAU À DESSERT**  
**DROIT LAME SCIE**  
DESSERT KNIFE SOLID HANDLE  
SERRATED  
20,9 CM - 8 IN<sup>3/16</sup>



**217142**  
**CUILLÈRE À CAFÉ**  
COFFEE/TEA SPOON  
14,3 CM - 5 IN<sup>5/8</sup>



**217146**  
**CUILLÈRE À MOKA**  
DEMI TASSE SPOON  
11,7 CM - 4 IN<sup>5/8</sup>



Articles supplémentaires de qualité vintage disponibles sur demande  
Additional vintage quality items available upon request

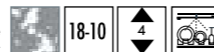



# L'EMPREINTE

Finedining

MADE IN FRANCE



**241006  
FOURCHETTE DE TABLE**  
TABLE FORK  
20,6 CM - 8 IN<sup>1/2</sup>



**241010  
COUTEAU DE TABLE MONOBLOC LAME SCIE**  
TABLE KNIFE SOLID HANDLE SERRATED  
23,9 CM - 9 IN<sup>7/16</sup>



**241004  
CUILLÈRE DE TABLE**  
TABLE/PASTA SPOON  
20,7 CM - 8 IN<sup>9/16</sup>



**241032  
CUILLÈRE À SOUPE ANGLAISE**  
BOUILLON SPOON, ROUND  
17,4 CM - 6 IN<sup>7/8</sup>



**241008  
CUILLÈRE À CAFÉ**  
COFFEE/TEA SPOON  
14,2 CM - 5 IN<sup>9/16</sup>



**241012  
CUILLÈRE À DESSERT**  
DESSERT/SOUP SPOON, OVAL  
18,6 CM - 7 IN<sup>5/16</sup>



**241014  
FOURCHETTE À DESSERT**  
DESSERT/SALAD FORK  
18,5 CM - 7 IN<sup>5/16</sup>



**241016  
COUTEAU À DESSERT MONOBLOC LAME UNIE**  
DESSERT KNIFE SOLID HANDLE  
21,5 CM - 8 IN<sup>7/16</sup>



**241018  
CUILLÈRE À MOKA**  
DEMI TASSE SPOON  
11,2 CM - 4 IN<sup>7/16</sup>



**241026  
FOURCHETTE À POISSON**  
FISH FORK  
18,5 CM - 7 IN<sup>5/16</sup>



**241028  
COUTEAU À POISSON**  
FISH KNIFE  
20,6 CM - 8 IN<sup>1/8</sup>



**241030  
COUTEAU À BEURRE MONOBLOC**  
BUTTER KNIFE SOLID HANDLE  
18,6 CM - 7 IN<sup>5/16</sup>



**241020  
CUILLÈRE DE SERVICE**  
SERVING SPOON  
26,1 CM - 10 IN<sup>3/4</sup>



**241021  
FOURCHETTE DE SERVICE**  
SERVING FORK  
26 CM - 10 IN<sup>3/4</sup>

EGALEMENT DISPONIBLE EN MÉTAL ARGENTÉ  
ALSO AVAILABLE IN SILVERPLATED FINISH



Possibilité de personnalisation  
Bespoke options available

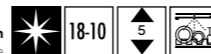



**239122**  
**FOURCHETTE DE TABLE**  
TABLE FORK  
20,5 CM - 8 IN<sup>1/8</sup>



**239123**  
**COUTEAU DE TABLE**  
**MONOBLOC À BOUT POINTU**  
**LAME SCIE**  
TABLE KNIFE SOLID HANDLE POINTED  
BLADE SERRATED  
23,3 CM - 9 IN<sup>3/8</sup>



**233014\***  
**COUTEAU DE TABLE**  
**MONOBLOC À BOUT ROND**  
**LAME SCIE**  
TABLE KNIFE SOLID HANDLE ROUNDED  
BLADE SERRATED  
23,3 CM - 9 IN<sup>3/8</sup>



**239121\***  
**CUILLÈRE DE TABLE**  
TABLE/PASTA SPOON  
20,5 CM - 8 IN<sup>1/8</sup>



**233022**  
**CUILLÈRE À SOUPE ANGLAISE**  
BOUILLON SPOON, ROUND  
18,5 CM - 7 IN<sup>5/8</sup>



**239128**  
**CUILLÈRE À DESSERT**  
DESSERT/SOUP SPOON, OVAL  
18,5 CM - 7 IN<sup>5/8</sup>



**239127\***  
**FOURCHETTE À DESSERT**  
DESSERT/SALAD FORK  
18,5 CM - 7 IN<sup>5/8</sup>



**239129\***  
**COUTEAU À DESSERT**  
**MONOBLOC À BOUT ROND**  
**LAME UNIE**  
DESSERT KNIFE SOLID HANDLE  
ROUNDED BLADE  
20,9 CM - 8 IN<sup>1/4</sup>



**239133**  
**COUTEAU À BEURRE**  
**MONOBLOC LAME UNIE**  
BUTTER KNIFE SOLID HANDLE  
17,5 CM - 6 IN<sup>7/8</sup>



**233021\***  
**CUILLÈRE GOURMET**  
GOURMET SPOON  
18,5 CM - 7 IN<sup>5/8</sup>



**239125**  
**CUILLÈRE À CAFÉ**  
COFFEE/TEA SPOON  
13,9 CM - 5 IN<sup>1/2</sup>



**239126**  
**CUILLÈRE À MOKA**  
DEMI TASSE SPOON  
11,7 CM - 4 IN<sup>5/8</sup>



**239134**  
**FOURCHETTE DE SERVICE**  
SERVING FORK  
26,3 CM - 10 IN<sup>3/8</sup>



**239135**  
**CUILLÈRE DE SERVICE**  
SERVING SPOON  
26,3 CM - 10 IN<sup>3/8</sup>

ÉGALEMENT DISPONIBLE EN MÉTAL ARGENTÉ  
ALSO AVAILABLE IN SILVERPLATED FINISH



Possibilité de personnalisation  
Bespoke options available

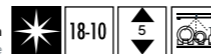

# MIRAGE

Alldaydining

MADE IN FRANCE



226167\*  
**FOURCHETTE DE TABLE**  
TABLE FORK  
21 CM - 8 IN<sup>1/4</sup>



226176\*  
**COUTEAU DE TABLE  
MONOBLOC LAME SCIE**  
TABLE KNIFE SOLID HANDLE SERRATED  
22,8 CM - 9 IN



226168\*  
**CUILLÈRE DE TABLE**  
TABLE/PASTA SPOON  
21 CM - 8 IN<sup>1/4</sup>



226172\*  
**CUILLÈRE À DESSERT**  
DESSERT/SOUP SPOON, OVAL  
18,9 CM - 7 IN<sup>7/16</sup>



226171\*  
**FOURCHETTE À DESSERT**  
DESSERT/SALAD FORK  
18,9 CM - 7 IN<sup>7/16</sup>



226178\*  
**COUTEAU À DESSERT  
MONOBLOC LAME UNIE**  
DESSERT KNIFE SOLID HANDLE  
20,5 CM - 8 IN<sup>1/16</sup>



226171\*  
**FOURCHETTE À POISSON**  
FISH FORK  
18,9 CM - 7 IN<sup>7/16</sup>



226169\*  
**CUILLÈRE À CAFÉ**  
COFFEE/TEA SPOON  
14,5 CM - 5 IN<sup>11/16</sup>



226170\*  
**CUILLÈRE À MOKA**  
DEMI TASSE SPOON  
11,6 CM - 4 IN<sup>9/16</sup>



226175\*  
**CUILLÈRE À SODA**  
ICED TEA SPOON  
19 CM - 7 IN<sup>1/2</sup>



226174\*  
**FOURCHETTE À GÂTEAUX/  
COCKTAIL**  
PASTRY/COCKTAIL FORK  
14,5 CM - 5 IN<sup>11/16</sup>



181112\*  
**TARTINEUR**  
BUTTER SPREADER  
16 CM - 6 IN<sup>5/16</sup>



EGALEMENT DISPONIBLE EN MÉTAL ARGENTÉ  
ALSO AVAILABLE IN SILVERPLATED FINISH



\*Arrêt à épuisement des stocks  
Until stock limited





**111894**  
**FOURCHETTE DE TABLE**  
TABLE FORK  
20,4 CM - 8 IN<sup>1/8</sup>



**111921**  
**COUTEAU DE TABLE**  
**MONOBLOC LAME SCIE**  
TABLE KNIFE SOLID HANDLE SERRATED  
23 CM - 9 IN<sup>1/8</sup>



**111891**  
**CUILLÈRE DE TABLE**  
TABLE/PASTA SPOON  
20,4 CM - 8 IN<sup>1/8</sup>



**111904**  
**CUILLÈRE À DESSERT**  
DESSERT/SOUP SPOON, OVAL  
18 CM - 7 IN<sup>1/8</sup>



**111907**  
**FOURCHETTE À DESSERT**  
DESSERT/SALAD FORK  
18 CM - 7 IN<sup>1/8</sup>



**210631**  
**COUTEAU À DESSERT**  
**MONOBLOC LAME SCIE**  
DESSERT KNIFE SOLID HANDLE  
SERRATED  
20,3 CM - 8 IN



**181112**  
**TARTINEUR**  
BUTTER SPREADER  
16 CM - 6 IN<sup>5/8</sup>



**111897**  
**CUILLÈRE À CAFÉ**  
COFFEE/TEA SPOON  
13,6 CM - 5 IN<sup>3/8</sup>



**114437**  
**CUILLÈRE À MOKA**  
DEMI TASSE SPOON  
11 CM - 4 IN<sup>5/8</sup>

EGALEMENT DISPONIBLE EN MÉTAL ARGENTÉ  
ALSO AVAILABLE IN SILVERPLATED FINISH



Possibilité de personnalisation  
Bespoke options available

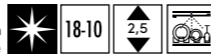

NORWAY

Alldaydining



ONDE

Finedining



235927  
**FOURCHETTE DE TABLE**  
TABLE FORK  
19,9 CM - 7 IN<sup>13/16</sup>



235930  
**COUTEAU DE TABLE  
MONOBLOC LAME SCIE**  
TABLE KNIFE SOLID HANDLE SERRATED  
23,2 CM - 9 IN<sup>1/8</sup>



235928  
**CUILLÈRE DE TABLE**  
TABLE/PASTA SPOON  
19,9 CM - 7 IN<sup>13/16</sup>



235938  
**CUILLÈRE À SOUPE ANGLAISE**  
BOUILLON SPOON, ROUND  
18,4 CM - 7 IN<sup>1/4</sup>



235934  
**CUILLÈRE À DESSERT**  
DESSERT/SOUP SPOON, OVAL  
18,4 CM - 7 IN<sup>1/4</sup>



235933  
**FOURCHETTE À DESSERT**  
DESSERT/SALAD FORK  
18,4 CM - 7 IN<sup>1/4</sup>



235935  
**COUTEAU À DESSERT  
MONOBLOC LAME SCIE**  
DESSERT KNIFE SOLID HANDLE  
SERRATED  
20,9 CM - 8 IN<sup>1/16</sup>



235939  
**COUTEAU À BEURRE  
MONOBLOC LAME UNIE**  
BUTTER KNIFE SOLID HANDLE  
16,5 CM - 6 IN<sup>1/2</sup>



235929  
**CUILLÈRE À CAFÉ**  
COFFEE/TEA SPOON  
13,9 CM - 5 IN<sup>1/2</sup>



235932  
**CUILLÈRE À MOKA**  
DEMI TASSE SPOON  
10,9 CM - 4 IN<sup>5/16</sup>



235937  
**FOURCHETTE À GÂTEAUX/  
COCKTAIL**  
PASTRY/COCKTAIL FORK  
14,1 CM - 5 IN<sup>9/16</sup>



231218  
**FOURCHETTE DE SERVICE**  
SERVING FORK  
26,6 CM - 10 IN<sup>1/2</sup>



231219  
**CUILLÈRE DE SERVICE**  
SERVING SPOON  
26,6 CM - 10 IN<sup>1/2</sup>



231221  
**PELLE À TARTE MONOBLOC**  
PASTRY SERVER SOLID HANDLE  
25,2 CM - 9 IN<sup>5/16</sup>





231220  
**LOUCHE**  
SOUP LADLE  
29 CM - 11 IN<sup>7/16</sup>

EGALEMENT DISPONIBLE EN MÉTAL ARGENTÉ  
ALSO AVAILABLE IN SILVERPLATED FINISH



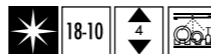

Possibilité de personnalisation  
Bespoke options available



- 

**236968**  
**FOURCHETTE DE TABLE**  
TABLE FORK  
19,9 CM - 7 IN<sup>3/16</sup>
- 

**239336**  
**COUTEAU DE TABLE**  
**MONOBLOC LAME SCIE**  
TABLE KNIFE SOLID HANDLE SERRATED  
23,2 CM - 9 IN<sup>1/8</sup>
- 

**236970**  
**CUILLÈRE DE TABLE**  
TABLE/PASTA SPOON  
19,9 CM - 7 IN<sup>3/16</sup>
- 

**236976**  
**CUILLÈRE À SOUPE ANGLAISE**  
BOUILLON SPOON, ROUND  
18,4 CM - 7 IN<sup>1/4</sup>
- 

**236971**  
**CUILLÈRE À DESSERT**  
DESSERT/SOUP SPOON, OVAL  
18,4 CM - 7 IN<sup>1/4</sup>
- 

**236972**  
**FOURCHETTE À DESSERT**  
DESSERT/SALAD FORK  
18,4 CM - 7 IN<sup>1/4</sup>
- 

**239337**  
**COUTEAU À DESSERT**  
**MONOBLOC LAME SCIE**  
DESSERT KNIFE SOLID HANDLE  
SERRATED  
20,9 CM - 8 IN<sup>3/16</sup>
- 

**236978**  
**COUTEAU À BEURRE**  
**MONOBLOC LAME UNIE**  
BUTTER KNIFE SOLID HANDLE  
16,5 CM - 6 IN<sup>1/2</sup>
- 

**236974**  
**CUILLÈRE À CAFÉ**  
COFFEE/TEA SPOON  
13,9 CM - 5 IN<sup>1/2</sup>
- 

**236975**  
**CUILLÈRE À MOKA**  
DEMI TASSE SPOON  
10,9 CM - 4 IN<sup>5/16</sup>
- 

**236977**  
**FOURCHETTE À COCKTAIL/**  
**ESCARGOTS**  
SNAIL/COCKTAIL FORK  
14,1 CM - 5 IN<sup>9/16</sup>
- 

**236981**  
**FOURCHETTE DE SERVICE**  
SERVING FORK  
26,6 CM - 10 IN<sup>1/2</sup>
- 

**236982**  
**CUILLÈRE DE SERVICE**  
SERVING SPOON  
26,6 CM - 10 IN<sup>1/2</sup>
- 

**237180**  
**PELLE À TARTE MONOBLOC**  
PASTRY SERVER SOLID HANDLE  
25,2 CM - 9 IN<sup>15/16</sup>

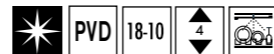

# ONDE GOLD

Finedining



OVATION

Finedining

MADE IN FRANCE

- 

**163598**  
**FOURCHETTE DE TABLE**  
TABLE FORK  
20,2 CM - 7 IN<sup>5/16</sup>
- 

**111970**  
**COUTEAU DE TABLE**  
**MONOBLOC LAME SCIE**  
TABLE KNIFE SOLID HANDLE SERRATED  
23 CM - 9 IN<sup>1/16</sup>
- 

**163597**  
**CUILLÈRE DE TABLE**  
TABLE/PASTA SPOON  
20,4 CM - 8 IN
- 

**163602**  
**CUILLÈRE À DESSERT**  
DESSERT/SOUP SPOON, OVAL  
18,5 CM - 7 IN<sup>1/4</sup>
- 

**163603**  
**FOURCHETTE À DESSERT**  
DESSERT/SALAD FORK  
18,5 CM - 7 IN<sup>1/4</sup>
- 

**111076**  
**COUTEAU À DESSERT**  
**MONOBLOC LAME UNIE**  
DESSERT KNIFE SOLID HANDLE  
20,4 CM - 8 IN
- 

**181112**  
**TARTINEUR**  
BUTTER SPREADER  
16 CM - 6 IN<sup>5/16</sup>
- 

**163599**  
**CUILLÈRE À CAFÉ**  
COFFEE/TEA SPOON  
14,1 CM - 5 IN<sup>9/16</sup>



EGALEMENT DISPONIBLE EN MÉTAL ARGENTÉ  
ALSO AVAILABLE IN SILVERPLATED FINISH



Possibilité de personnalisation  
Bespoke options available

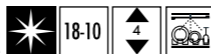

# SOLSTICE

Alldaydining

MADE IN FRANCE



**205540  
FOURCHETTE DE TABLE**  
TABLE FORK  
20,9 CM - 8 IN<sup>3/16</sup>



**205544  
FOURCHETTE À POISSON**  
FISH FORK  
18,4 CM - 7 IN<sup>1/4</sup>



**159484  
COUTEAU DE TABLE N°1  
MONOBLOC LAME SCIE**  
TABLE KNIFE SOLID HANDLE SERRATED  
23,2 CM - 9 IN<sup>5/8</sup>



**205545  
COUTEAU À POISSON/GOURMET**  
GOURMET FISH KNIFE  
20,7 CM - 8 IN<sup>1/8</sup>



**235481  
COUTEAU DE TABLE  
MONOBLOC LAME SCIE**  
TABLE KNIFE SOLID HANDLE SERRATED  
23,7 CM - 9 IN<sup>5/16</sup>



**205543  
CUILLÈRE À CAFÉ**  
COFFEE/TEA SPOON  
14 CM - 5 IN<sup>1/2</sup>



**159451  
COUTEAU À STEAK  
MONOBLOC LAME SCIE**  
STEAK KNIFE SOLID HANDLE SERRATED  
23,5 CM - 9 IN<sup>1/4</sup>



**159512  
CUILLÈRE À MOKA**  
DEMI TASSE SPOON  
11,1 CM - 4 IN<sup>3/8</sup>



**190018  
CUILLÈRE À SODA**  
ICED TEA SPOON  
19 CM - 7 IN<sup>1/2</sup>



**235482  
COUTEAU DESSERT  
MONOBLOC LAME UNIE**  
DESSERT KNIFE SOLID HANDLE  
21,3 CM - 8 IN<sup>3/8</sup>



**205548  
FOURCHETTE À GÂTEAUX/COCKTAIL**  
PASTRY/COCKTAIL FORK  
14,3 CM - 5 IN<sup>5/8</sup>



**205541  
CUILLÈRE DE TABLE**  
TABLE/PASTA SPOON  
20,9 CM - 8 IN<sup>3/4</sup>



**190424  
FOURCHETTE À HÙÎTRES**  
OYSTER FORK  
14,1 CM - 5 IN<sup>3/16</sup>



**205547  
CUILLÈRE À DESSERT**  
DESSERT/SOUP SPOON, OVAL  
18,4 CM - 7 IN<sup>1/4</sup>



**159501  
FOURCHETTE DE SERVICE**  
SERVING FORK  
26 CM - 10 IN<sup>1/4</sup>



**205546  
FOURCHETTE À DESSERT**  
DESSERT/SALAD FORK  
18,4 CM - 7 IN<sup>1/4</sup>



**159500  
CUILLÈRE DE SERVICE**  
SERVING SPOON  
26 CM - 10 IN<sup>1/4</sup>



**159492  
COUTEAU À DESSERT N°1  
MONOBLOC LAME UNIE**  
DESSERT KNIFE SOLID HANDLE  
20,4 CM - 8 IN<sup>1/16</sup>



**153193  
LOUCHE**  
SOUP LADLE  
29,7 CM - 11 IN<sup>11/16</sup>



**181112  
TARTINEUR**  
BUTTER SPREADER  
16 CM - 6 IN<sup>5/16</sup>



**154606  
CUILLÈRE À SAUCE**  
SAUCE SPOON  
18,5 CM - 7 IN<sup>5/16</sup>

EGALEMENT DISPONIBLE EN MÉTAL ARGENTÉ  
ALSO AVAILABLE IN SILVERPLATED FINISH



Possibilité de personnalisation  
Bespoke options available

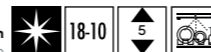



XY

Finedining

MADE IN FRANCE



**205559**  
**FOURCHETTE DE TABLE**  
TABLE FORK  
21,3 CM - 8 IN<sup>5/16</sup>



**193776**  
**COUTEAU DE TABLE**  
**MONOBLOC LAME SCIE**  
TABLE KNIFE SOLID HANDLE SERRATED  
23,3 CM - 9 IN<sup>3/16</sup>



**205560**  
**CUILLÈRE DE TABLE**  
TABLE/PASTA SPOON  
20,5 CM - 8 IN<sup>1/16</sup>



**205561**  
**CUILLÈRE À SOUPE ANGLAISE**  
BOUILLON SPOON, ROUND  
18,5 CM - 7 IN<sup>3/16</sup>



**205567**  
**CUILLÈRE GOURMANDE**  
DESSERT /SOUP SPOON, OVAL  
18,6 CM - 7 IN<sup>5/16</sup>



**205566**  
**FOURCHETTE GOURMANDE**  
DESSERT/SALAD FORK  
18,6 CM - 7 IN<sup>5/16</sup>



**181111**  
**COUTEAU À DESSERT**  
**MONOBLOC LAME UNIE**  
DESSERT KNIFE SOLID HANDLE  
20,6 CM - 8 IN<sup>1/16</sup>



**181112**  
**TARTINEUR**  
BUTTER SPREADER  
16 CM - 6 IN<sup>5/16</sup>



**205563**  
**FOURCHETTE À POISSON**  
FISH FORK  
20 CM - 7 IN<sup>7/8</sup>



**205564**  
**SPATULE GOURMET**  
GOURMET SPATULA  
20,2 CM - 7 IN<sup>15/16</sup>



**205565**  
**FOURCHETTE GOURMET**  
GOURMET FORK  
20 CM - 7 IN<sup>7/8</sup>



**205562**  
**CUILLÈRE À CAFÉ**  
COFFEE/TEA SPOON  
14,3 CM - 5 IN<sup>5/16</sup>



**181109**  
**CUILLÈRE À MOKA**  
DEMI TASSE SPOON  
11 CM - 4 IN<sup>5/16</sup>



**190018**  
**CUILLÈRE À SODA**  
ICED TEA SPOON  
19 CM - 7 IN<sup>1/2</sup>



**181119**  
**FOURCHETTE MISE EN BOUCHE**  
COCKTAIL FORK  
15,5 CM - 6 IN<sup>9/16</sup>



**181120**  
**SPATULE MISE EN BOUCHE**  
COCKTAIL SPATULA  
15,5 CM - 6 IN<sup>9/16</sup>



**181121**  
**CUILLÈRE MISE EN BOUCHE**  
COCKTAIL SPOON  
11,6 CM - 4 IN<sup>9/16</sup>



**190424**  
**FOURCHETTE À HÙÎTRES**  
OYSTER FORK  
14,1 CM - 5 IN<sup>3/16</sup>



**181114**  
**FOURCHETTE DE SERVICE**  
SERVING FORK  
26 CM - 10 IN<sup>1/4</sup>



**181113**  
**CUILLÈRE DE SERVICE**  
SERVING SPOON  
26 CM - 10 IN<sup>1/4</sup>



**181122**  
**SPATULE DE SERVICE**  
SERVING SPATULA  
25 CM - 9 IN<sup>13/16</sup>



**189999**  
**SERVICE À SALADE**  
SALAD SERVING SET  
30 CM - 11 IN<sup>13/16</sup>



**153193**  
**LOUCHE**  
SOUP LADLE  
29,7 CM - 11 IN<sup>11/16</sup>



**154606**  
**LOUCHE À SAUCE**  
SAUCE LADLE  
18,5 CM - 7 IN<sup>5/16</sup>

EGALEMENT DISPONIBLE EN MÉTAL ARGENTÉ  
ALSO AVAILABLE IN SILVERPLATED FINISH



Possibilité de personnalisation  
Bespoke options available

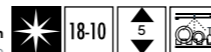

L'abus d'alcool est dangereux pour la santé  
Alcohol abuse is dangerous for your health

# XY BLACK MIROIR

Finedining

MADE IN FRANCE



**205568**  
**FOURCHETTE DE TABLE**  
TABLE FORK  
21,3 CM - 8 IN<sup>3/8</sup>



**195028**  
**COUTEAU DE TABLE**  
**MONOBLOC LAME SCIE**  
TABLE KNIFE SOLID HANDLE SERRATED  
23,3 CM - 9 IN<sup>3/16</sup>



**205569**  
**CUILLÈRE DE TABLE**  
TABLE/PASTA SPOON  
20,5 CM - 8 IN<sup>1/16</sup>



**200483**  
**CUILLÈRE À SOUPE ANGLAISE**  
BOUILLON SPOON, ROUND  
18,5 CM - 7 IN<sup>5/16</sup>



**205575**  
**CUILLÈRE GOURMANDE**  
DESSERT/SOUP SPOON, OVAL  
18,6 CM - 7 IN<sup>5/16</sup>



**205574**  
**FOURCHETTE GOURMANDE**  
DESSERT/SALAD FORK  
18,6 CM - 7 IN<sup>5/16</sup>



**195031**  
**COUTEAU À DESSERT**  
**MONOBLOC LAME UNIE**  
DESSERT KNIFE SOLID HANDLE  
20,6 CM - 8 IN<sup>1/16</sup>



**195036**  
**TARTINEUR**  
BUTTER SPREADER  
16 CM - 6 IN<sup>5/16</sup>



**205571**  
**FOURCHETTE À POISSON**  
FISH FORK  
20 CM - 7 IN<sup>7/16</sup>



**205572**  
**SPATULE GOURMET**  
GOURMET SPATULA  
20,2 CM - 7 IN<sup>15/16</sup>



**205573**  
**FOURCHETTE GOURMET**  
GOURMET FORK  
20 CM - 7 IN<sup>7/16</sup>



**205570**  
**CUILLÈRE À CAFÉ**  
COFFEE/TEA SPOON  
14,3 CM - 5 IN<sup>5/16</sup>



**195034**  
**CUILLÈRE À MOKA**  
DEMI TASSE SPOON  
11 CM - 4 IN<sup>5/16</sup>



**196674**  
**CUILLÈRE À SODA**  
ICED TEA SPOON  
19 CM - 7 IN<sup>1/2</sup>



**195039**  
**FOURCHETTE MISE EN BOUCHE**  
COCKTAIL FORK  
15,5 CM - 6 IN<sup>1/8</sup>



**195042**  
**SPATULE MISE EN BOUCHE**  
COCKTAIL SPATULA  
15,5 CM - 6 IN<sup>1/8</sup>



**195041**  
**CUILLÈRE MISE EN BOUCHE**  
COCKTAIL SPOON  
11,6 CM - 4 IN<sup>3/16</sup>



**196014**  
**FOURCHETTE À HÙÎTRES**  
OYSTER FORK  
14,1 CM - 5 IN<sup>3/16</sup>



**199773**  
**FOURCHETTE DE SERVICE**  
SERVING FORK  
26 CM - 10 IN<sup>1/4</sup>



**199774**  
**CUILLÈRE DE SERVICE**  
SERVING SPOON  
26 CM - 10 IN<sup>1/4</sup>



**199769**  
**SPATULE DE SERVICE**  
SERVING SPATULA  
25 CM - 9 IN<sup>13/16</sup>



**199771**  
**SERVICE À SALADE**  
SALAD SERVING SET  
30 CM - 11 IN<sup>13/16</sup>

Possibilité de personnalisation  
Bespoke options available





LES  
COUVERTS  
CLASSIQUES  
CLASSICAL FLATWARE



**126556**  
**FOURCHETTE DE TABLE**  
TABLE FORK  
20,2 CM - 7 IN<sup>15/16</sup>



**126565**  
**COUTEAU DE TABLE**  
**MANCHE ORFÈVRE LAME UNIE**  
TABLE KNIFE HOLLOW HANDLE  
23 CM - 9 IN<sup>17/16</sup>



**130332**  
**COUTEAU DE TABLE**  
**MANCHE ORFÈVRE LAME SCIE**  
TABLE KNIFE HOLLOW HANDLE SERRATED  
23 CM - 9 IN<sup>17/16</sup>



**126553**  
**CUILLÈRE DE TABLE**  
TABLE/PASTA SPOON  
20,5 CM - 8 IN<sup>17/16</sup>



**126559**  
**CUILLÈRE À CAFÉ**  
COFFEE/TEA SPOON  
13,9 CM - 5 IN<sup>1/2</sup>



**155528**  
**CUILLÈRE À SOUPE ANGLAISE**  
BOUILLON SPOON, ROUND  
17,5 CM - 6 IN<sup>7/8</sup>



**155452**  
**CUILLÈRE À MOKA**  
DEMI TASSE SPOON  
11,1 CM - 4 IN<sup>3/8</sup>



**126569**  
**CUILLÈRE À DESSERT**  
DESSERT/SOUP SPOON, OVAL  
18 CM - 7 IN<sup>17/16</sup>



**126591**  
**FOURCHETTE DE SERVICE**  
SERVING FORK  
24,8 CM - 9 IN<sup>3/4</sup>



**126572**  
**FOURCHETTE À DESSERT**  
DESSERT/SALAD FORK  
18 CM - 7 IN<sup>17/16</sup>



**126589**  
**CUILLÈRE DE SERVICE**  
SERVING SPOON  
25 CM - 9 IN<sup>17/16</sup>



**126575**  
**COUTEAU À DESSERT**  
**MANCHE ORFÈVRE LAME UNIE**  
DESSERT KNIFE HOLLOW HANDLE  
20,5 CM - 8 IN<sup>17/16</sup>



**126587**  
**PELLE À TARTE**  
**MANCHE ORFÈVRE**  
PASTRY SERVER HOLLOW HANDLE  
24 CM - 9 IN<sup>17/16</sup>



**154828**  
**COUTEAU À BEURRE**  
**MANCHE ORFÈVRE LAME UNIE**  
BUTTER KNIFE HOLLOW HANDLE  
18,8 CM - 7 IN<sup>3/8</sup>



**126578**  
**FOURCHETTE À POISSON**  
FISH FORK  
18 CM - 7 IN<sup>17/16</sup>



**126581**  
**COUTEAU À POISSON**  
FISH KNIFE  
20,1 CM - 7 IN<sup>15/16</sup>



BLOIS

Finedining

MADE IN FRANCE



104485  
**FOURCHETTE DE TABLE**  
TABLE FORK  
20,8 CM - 8 IN<sup>3/16</sup>



182466  
**COUTEAU DE TABLE  
MONOBLOC LOURD LAME SCIE**  
TABLE KNIFE HEAVY SOLID HANDLE  
SERRATED  
24,6 CM - 9 IN<sup>17/16</sup>



161390  
**COUTEAU DE TABLE  
MANCHE ORFÈVRE DROIT LAME UNIE**  
TABLE KNIFE HOLLOW HANDLE  
24,6 CM - 9 IN<sup>17/16</sup>



161391  
**COUTEAU DE TABLE  
MANCHE ORFÈVRE LAME SCIE**  
TABLE KNIFE HOLLOW HANDLE SERRATED  
24,6 CM - 9 IN<sup>17/16</sup>



122759  
**COUTEAU À STEAK  
MANCHE ORFÈVRE LAME SCIE**  
STEAK KNIFE HOLLOW HANDLE SERRATED  
23,9 CM - 9 IN<sup>7/16</sup>



104526  
**CUILLÈRE DE TABLE**  
TABLE/PASTA SPOON  
20,8 CM - 8 IN<sup>3/16</sup>



104448  
**CUILLÈRE À SOUPE ANGLAISE**  
BOUILLON SPOON, ROUND  
17,2 CM - 6 IN<sup>3/4</sup>



104484  
**CUILLÈRE À DESSERT**  
DESSERT/SOUP SPOON, OVAL  
18 CM - 7 IN<sup>1/16</sup>



104543  
**FOURCHETTE À DESSERT**  
DESSERT/SALAD FORK  
17,8 CM - 7 IN



182467  
**COUTEAU À DESSERT  
MONOBLOC LOURD LAME UNIE**  
DESSERT KNIFE HEAVY SOLID HANDLE  
20,5 CM - 8 IN<sup>1/16</sup>



161394  
**COUTEAU À DESSERT  
MANCHE ORFÈVRE LAME UNIE**  
DESSERT KNIFE HOLLOW HANDLE  
20,5 CM - 8 IN<sup>1/16</sup>



190419  
**COUTEAU À BEURRE  
MONOBLOC LOURD LAME UNIE**  
BUTTER KNIFE HEAVY SOLID HANDLE  
18,7 CM - 7 IN<sup>3/8</sup>



122760  
**COUTEAU À BEURRE  
MANCHE ORFÈVRE LAME UNIE**  
BUTTER KNIFE HOLLOW HANDLE  
18,7 CM - 7 IN<sup>3/8</sup>

EGALEMENT DISPONIBLE EN MÉTAL ARGENTÉ  
ALSO AVAILABLE IN SILVERPLATED FINISH



Possibilité de personnalisation  
Bespoke options available

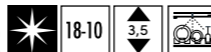

# BLOIS

Finedining

MADE IN FRANCE



**104507**  
**FOURCHETTE POISSON**  
FISH FORK  
17,8 CM - 7 IN



**104508**  
**COUTEAU POISSON**  
FISH KNIFE  
19,7 CM - 7 IN<sup>3/4</sup>



**145451**  
**CUILLÈRE À SAUCE GOURMET**  
GOURMET/SAUCE SPOON  
17,9 CM - 7 IN<sup>1/16</sup>



**104561**  
**CUILLÈRE À CAFÉ**  
COFFEE/TEA SPOON  
14 CM - 5 IN<sup>1/2</sup>



**109465**  
**CUILLÈRE À MOKA**  
DEMI TASSE SPOON  
11 CM - 4 IN<sup>5/16</sup>



**124259**  
**CUILLÈRE À SODA**  
ICED TEA SPOON  
18,2 CM - 7 IN<sup>3/16</sup>



**104480**  
**FOURCHETTE À GÂTEAUX/  
COCKTAIL**  
PASTRY/COCKTAIL FORK  
13,8 CM - 5 IN<sup>7/16</sup>



**104463**  
**FOURCHETTE À HUITRES**  
OYSTER FORK  
12,9 CM - 5 IN<sup>1/16</sup>



**189208**  
**COUTEAU À FROMAGE**  
**MANCHE ORFÈVRE LAME UNIE**  
CHEESE KNIFE HOLLOW HANDLE  
19,3 CM - 7 IN<sup>5/16</sup>



**195757**  
**FOURCHETTE DE SERVICE**  
SERVING FORK  
24,8 CM - 9 IN<sup>3/4</sup>



**195755**  
**CUILLÈRE DE SERVICE**  
SERVING SPOON  
25 CM - 9 IN<sup>15/16</sup>



**195757**  
**FOURCHETTE À DÉCOUPER**  
CARVING FORK  
24,8 CM - 9 IN<sup>3/4</sup>



**189511**  
**COUTEAU À DÉCOUPER**  
**MANCHE ORFÈVRE LAME UNIE**  
CARVING KNIFE HOLLOW HANDLE  
28,7 CM - 11 IN<sup>5/16</sup>



**195750**  
**SERVICE À SALADE**  
SALADE SERVING SET  
25,7 CM - 10 IN<sup>1/8</sup>



**195753**  
**PELLE À TARTE MONOBLOC**  
PASTRY SERVER SOLID HANDLE  
24,9 CM - 9 IN<sup>13/16</sup>



**195762**  
**LOUCHE**  
SOUP LADLE  
29,8 CM - 11 IN<sup>3/4</sup>



**195759**  
**LOUCHE À SAUCE**  
SAUCE LADLE  
15,7 CM - 6 IN<sup>3/16</sup>

ÉGALEMENT DISPONIBLE EN MÉTAL ARGENTÉ  
ALSO AVAILABLE IN SILVERPLATED FINISH



Possibilité de personnalisation  
Bespoke options available

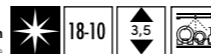

# CONFIDENCE

All day dining



**141094**  
**FOURCHETTE DE TABLE**  
TABLE FORK  
20,3 CM - 8 IN



**103857**  
**COUTEAU DE TABLE**  
**MONOBLOC LAME SCIE**  
TABLE KNIFE SOLID HANDLE  
SERRATED  
23,7 CM - 9 IN<sup>5/16</sup>



**160433**  
**COUTEAU À STEAK**  
**MONOBLOC LAME SCIE**  
STEAK KNIFE SOLID HANDLE SERRATED  
23,6 CM - 9 IN<sup>5/16</sup>



**141092**  
**CUILLÈRE DE TABLE**  
TABLE/PASTA SPOON  
20,4 CM - 8 IN<sup>17/16</sup>



**105908**  
**CUILLÈRE À SOUPE ANGLAISE**  
BOUILLON SPOON, ROUND  
17,2 CM - 6 IN<sup>3/4</sup>



**108232**  
**CUILLÈRE À DESSERT**  
DESSERT/SOUP SPOON, OVAL  
17,9 CM - 7 IN<sup>11/16</sup>



**108234**  
**FOURCHETTE À DESSERT**  
DESSERT/SALAD FORK  
17,8 CM - 7 IN



**210628**  
**COUTEAU À DESSERT**  
**MONOBLOC LAME SCIE**  
DESSERT KNIFE SOLID HANDLE  
20,6 CM - 8 IN<sup>17/16</sup>



**103564**  
**CUILLÈRE À CAFÉ**  
COFFEE/TEA SPOON  
13,5 CM - 5 IN<sup>5/16</sup>



**109471**  
**CUILLÈRE À MOKA**  
DEMI TASSE SPOON  
11 CM - 4 IN<sup>5/16</sup>



**105800**  
**CUILLÈRE À SODA**  
ICED TEA SPOON  
18,2 CM - 7 IN<sup>3/16</sup>



**132782**  
**FOURCHETTE À ESCARGOTS**  
SNAIL FORK  
13,5 CM - 5 IN<sup>5/16</sup>



**002185**  
**FOURCHETTE DE SERVICE**  
SERVING FORK  
24,8 CM - 9 IN<sup>3/4</sup>



**002186**  
**CUILLÈRE DE SERVICE**  
SERVING SPOON  
25 CM - 9 IN<sup>13/16</sup>



**040646**  
**SERVICE À SALADE**  
SALAD SERVING SET  
25,8 CM - 10 IN<sup>3/16</sup>



**083340**  
**PELLE À TARTE MONOBLOC**  
PASTRY SERVER SOLID HANDLE  
24,9 CM - 9 IN<sup>13/16</sup>



**097717**  
**LOUCHE**  
SOUP LADLE  
29,8 CM - 11 IN<sup>3/4</sup>



**002179**  
**LOUCHE À SAUCE**  
SAUCE LADLE  
15,7 CM - 6 IN<sup>3/16</sup>

EGALEMENT DISPONIBLE EN MÉTAL ARGENTÉ  
ALSO AVAILABLE IN SILVERPLATED FINISH



Possibilité de personnalisation  
Bespoke options available

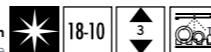

# CONTOUR

Alldaydining

MADE IN FRANCE

NEW

- **104729**  
**FOURCHETTE DE TABLE**  
TABLE FORK  
21 CM - 8 IN<sup>1/4</sup>
- **104728**  
**COUTEAU DE TABLE**  
**MANCHE ORFEVRE LAME SCIE**  
TABLE KNIFE HOLLOW HANDLE  
SERRATED  
25 CM - 9 IN<sup>13/16</sup>
- **104712**  
**CUILLÈRE DE TABLE**  
TABLE/PASTA SPOON  
21 CM - 8 IN<sup>1/4</sup>
- **186291**  
**CUILLÈRE À SOUPE ANGLAISE**  
BOUILLON SPOON, ROUND  
17,4 CM - 8 IN<sup>7/8</sup>
- **104752**  
**CUILLÈRE À DESSERT**  
DESSERT/SOUP SPOON, OVAL  
18,1 CM - 7 IN<sup>9/8</sup>
- **104765**  
**FOURCHETTE À DESSERT**  
DESSERT/SALAD FORK  
18,1 CM - 7 IN<sup>9/8</sup>
- **104779**  
**COUTEAU À DESSERT**  
**MANCHE ORFEVRE LAME UNIE**  
DESSERT KNIFE HOLLOW HANDLE  
21 CM - 8 IN<sup>1/4</sup>
- **186294**  
**COUTEAU À BEURRE**  
**MANCHE ORFEVRE**  
BUTTER KNIFE HOLLOW HANDLE  
19,2 CM - 7 IN<sup>9/16</sup>
- **104766**  
**CUILLÈRE À CAFÉ**  
COFFEE/TEA SPOON  
14,4 CM - 5 IN<sup>11/16</sup>
- **104707**  
**FOURCHETTE À POISSON**  
FISH FORK  
17,9 CM - 7 IN<sup>17/16</sup>
- **104727**  
**COUTEAU À POISSON**  
FISH KNIFE  
20 CM - 7 IN<sup>7/8</sup>



EGALEMENT DISPONIBLE EN MÉTAL ARGENTÉ  
ALSO AVAILABLE IN SILVERPLATED FINISH



Possibilité de personnalisation  
Bespoke options available

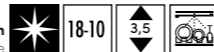



# FLORENCIA

Finedining

MADE IN FRANCE



**126077**  
**FOURCHETTE DE TABLE**  
TABLE FORK  
20,8 CM - 8 IN<sup>3/16</sup>



**190643**  
**COUTEAU DE TABLE**  
**MONOBLOC LOURD**  
**MANCHE DROIT LAME SCIE**  
TABLE KNIFE HEAVY SOLID HANDLE SERRATED  
24,6 CM - 9 IN<sup>3/16</sup>



**130140**  
**COUTEAU DE TABLE**  
**MANCHE ORFÈVRE DROIT LAME SCIE**  
TABLE KNIFE HOLLOW HANDLE SERRATED  
24,6 CM - 9 IN<sup>3/16</sup>



**127654**  
**COUTEAU À STEAK**  
**MANCHE ORFÈVRE DROIT LAME SCIE**  
STEAK KNIFE HOLLOW HANDLE SERRATED  
23,9 CM - 9 IN<sup>7/16</sup>



**126074**  
**CUILLÈRE DE TABLE**  
TABLE/PASTA SPOON  
20,8 CM - 8 IN<sup>3/16</sup>



**126090**  
**CUILLÈRE À DESSERT**  
DESSERT/SOUP SPOON, OVAL  
18 CM - 7 IN<sup>7/16</sup>



**126093**  
**FOURCHETTE À DESSERT**  
DESSERT/SALAD FORK  
17,8 CM - 7 IN



**190644**  
**COUTEAU À DESSERT**  
**MONOBLOC LOURD MANCHE**  
**DROIT LAME SCIE**  
DESSERT KNIFE HEAVY SOLID HANDLE  
SERRATED  
20,5 CM - 8 IN<sup>7/16</sup>



**126096**  
**COUTEAU À DESSERT**  
**MANCHE ORFÈVRE LAME UNIE**  
DESSERT KNIFE HOLLOW HANDLE  
20,5 CM - 8 IN<sup>7/16</sup>



**190417**  
**COUTEAU À BEURRE**  
**MONOBLOC LOURD MANCHE**  
**DROIT LAME UNIE**  
BUTTER KNIFE HEAVY SOLID HANDLE  
18,7 CM - 7 IN<sup>3/8</sup>



**129344**  
**COUTEAU À BEURRE**  
**MANCHE DROIT LAME UNIE**  
BUTTER KNIFE SOLID HANDLE  
18,7 CM - 7 IN<sup>3/8</sup>



**126099**  
**FOURCHETTE À POISSON**  
FISH FORK  
17,7 CM - 6 IN<sup>15/16</sup>



**126102**  
**COUTEAU À POISSON**  
FISH KNIFE  
19,9 CM - 7 IN<sup>13/16</sup>



**126080**  
**CUILLÈRE À CAFÉ**  
COFFEE/TEA SPOON  
14 CM - 5 IN<sup>1/2</sup>



**126105**  
**CUILLÈRE À MOKA**  
DEMI TASSE SPOON  
11 CM - 4 IN<sup>9/16</sup>



**126108**  
**FOURCHETTE À GÂTEAUX/COCKTAIL**  
PASTRY/COCKTAIL FORK  
13,8 CM - 5 IN<sup>7/16</sup>



**190418**  
**FOURCHETTE À HÛÎTRES**  
OYSTER FORK  
13 CM - 5 IN<sup>7/8</sup>

**PIÈCES DE SERVICE**  
SERVING PIECES

**VERLAINE**  
P. 156



ÉGALEMENT DISPONIBLE EN MÉTAL ARGENTÉ  
ALSO AVAILABLE IN SILVERPLATED FINISH



Possibilité de personnalisation  
Bespoke options available

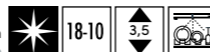

LUTÈCE

Finedining

MADE IN FRANCE



**105021**  
**FOURCHETTE DE TABLE**  
TABLE FORK  
20,9 CM - 8 IN<sup>5/16</sup>



**190415**  
**COUTEAU DE TABLE**  
**MONOBLOC LOURD LAME SCIE**  
TABLE KNIFE HEAVY SOLID HANDLE SERRATED  
24,8 CM - 9 IN<sup>3/4</sup>



**105006**  
**COUTEAU DE TABLE**  
**MANCHE ORFÈVRE LAME SCIE**  
TABLE KNIFE HOLLOW HANDLE SERRATED  
24,7 CM - 9 IN<sup>3/4</sup>



**122746**  
**COUTEAU À STEAK**  
**MANCHE ORFÈVRE LAME SCIE**  
STEAK KNIFE HOLLOW HANDLE SERRATED  
23,8 CM - 9 IN<sup>3/8</sup>



**104988**  
**CUILLÈRE DE TABLE**  
TABLE/PASTA SPOON  
21,1 CM - 8 IN<sup>5/16</sup>



**104985**  
**CUILLÈRE À DESSERT**  
DESSERT/SOUP SPOON, OVAL  
18 CM - 7 IN<sup>11/16</sup>



**105013**  
**FOURCHETTE À DESSERT**  
DESSERT/SALAD FORK  
17,9 CM - 7 IN<sup>7/16</sup>



**190416**  
**COUTEAU À DESSERT**  
**MONOBLOC LOURD LAME UNIE**  
DESSERT KNIFE HEAVY SOLID HANDLE  
21,3 CM - 8 IN<sup>3/8</sup>



**104989**  
**COUTEAU À DESSERT**  
**MANCHE ORFÈVRE LAME UNIE**  
DESSERT KNIFE HOLLOW HANDLE  
20,6 CM - 8 IN<sup>1/8</sup>



**190414**  
**COUTEAU À BEURRE**  
**MONOBLOC LOURD**  
**LAME UNIE**  
BUTTER KNIFE HEAVY SOLID HANDLE  
19,7 CM - 7 IN<sup>3/4</sup>



**016394**  
**COUTEAU À BEURRE**  
**MANCHE ORFÈVRE LAME UNIE**  
BUTTER KNIFE HOLLOW HANDLE  
18,9 CM - 7 IN<sup>7/16</sup>



**104994**  
**FOURCHETTE À POISSON**  
FISH FORK  
17,9 CM - 7 IN<sup>11/16</sup>



**104995**  
**COUTEAU À POISSON**  
FISH KNIFE  
20 CM - 7 IN<sup>7/8</sup>



**104986**  
**CUILLÈRE À CAFÉ**  
COFFEE/TEA SPOON  
14,1 CM - 5 IN<sup>9/16</sup>



**104993**  
**CUILLÈRE À MOKA**  
DEMI TASSE SPOON  
11,2 CM - 4 IN<sup>7/16</sup>



**105012**  
**FOURCHETTE À GÂTEAUX/**  
**COCKTAIL**  
PASTRY/COCKTAIL FORK  
13,9 CM - 5 IN<sup>1/2</sup>

EGALEMENT DISPONIBLE EN MÉTAL ARGENTÉ  
ALSO AVAILABLE IN SILVERPLATED FINISH



Possibilité de personnalisation  
Bespoke options available

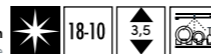



**182968**  
**FOURCHETTE DE TABLE**  
TABLE FORK  
20,8 CM - 8 IN<sup>5/16</sup>



**182970**  
**COUTEAU DE TABLE**  
**MANCHE ORFÈVRE LAME SCIE**  
TABLE KNIFE HOLLOW HANDLE SERRATED  
24,6 CM - 9 IN<sup>11/16</sup>



**186278**  
**COUTEAU À STEAK**  
**MANCHE ORFÈVRE LAME SCIE**  
STEAK KNIFE HOLLOW HANDLE SERRATED  
23,9 CM - 9 IN<sup>7/16</sup>



**182967**  
**CUILLÈRE DE TABLE**  
TABLE/PASTA SPOON  
20,8 CM - 8 IN<sup>5/16</sup>



**186276**  
**CUILLÈRE À SOUPE ANGLAISE**  
BOUILLON SPOON, ROUND  
17,4 CM - 6 IN<sup>7/8</sup>



**182974**  
**CUILLÈRE À DESSERT**  
DESSERT/SOUP SPOON, OVAL  
18 CM - 7 IN<sup>1/16</sup>



**182975**  
**FOURCHETTE À DESSERT**  
DESSERT/SALAD FORK  
17,8 CM - 7 IN



**182971**  
**COUTEAU À DESSERT**  
**MANCHE ORFÈVRE LAME UNIE**  
DESSERT KNIFE HOLLOW HANDLE  
20,5 CM - 8 IN<sup>1/16</sup>



**186279**  
**COUTEAU À BEURRE**  
**MANCHE ORFÈVRE LAME UNIE**  
BUTTER KNIFE HOLLOW HANDLE  
18,7 CM - 7 IN<sup>3/8</sup>



**182972**  
**FOURCHETTE À POISSON**  
FISH FORK  
17,7 CM - 6 IN<sup>15/16</sup>



**182973**  
**COUTEAU À POISSON**  
FISH KNIFE  
19,9 CM - 7 IN<sup>13/16</sup>



**182969**  
**CUILLÈRE À CAFÉ**  
COFFEE/TEA SPOON  
14 CM - 5 IN<sup>1/2</sup>



**182976**  
**CUILLÈRE À MOKA**  
DEMI TASSE SPOON  
11 CM - 4 IN<sup>5/16</sup>



**186274**  
**FOURCHETTE À GÂTEAUX/**  
**COCKTAIL**  
PASTRY/COCKTAIL FORK  
13,8 CM - 5 IN<sup>7/16</sup>



**190681**  
**FOURCHETTE À HÛÎTRES**  
OYSTER FORK  
13 CM - 5 IN<sup>1/8</sup>

**PIÈCES DE SERVICE**  
SERVING PIECES

**VERLAINE**  
P. 156

ÉGALEMENT DISPONIBLE EN MÉTAL ARGENTÉ  
ALSO AVAILABLE IN SILVERPLATED FINISH



Possibilité de personnalisation  
Bespoke options available

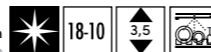

**MARQUISE**

Finedining

MADE IN FRANCE





**141089**  
**FOURCHETTE DE TABLE**  
TABLE FORK  
20,3 CM - 8 IN



**103550**  
**CUILLÈRE À CAFÉ**  
COFFEE/TEA SPOON  
13,5 CM - 5 IN<sup>5/16</sup>



**113017**  
**COUTEAU DE TABLE**  
**MONOBLOC LOURD**  
**LAME SCIE**  
TABLE KNIFE HEAVY SOLID HANDLE  
SERRATED  
24,4 CM - 9 IN<sup>5/8</sup>



**109465**  
**CUILLÈRE À MOKA**  
DEMI TASSE SPOON  
11 CM - 4 IN<sup>5/16</sup>



**160427**  
**COUTEAU À STEAK**  
**MONOBLOC LAME SCIE**  
STEAK KNIFE SOLID HANDLE  
SERRATED  
23,2 CM - 9 IN<sup>5/8</sup>



**124259**  
**CUILLÈRE À SODA**  
ICED TEA SPOON  
18,2 CM - 7 IN<sup>3/16</sup>



**141086**  
**CUILLÈRE DE TABLE**  
TABLE/PASTA SPOON  
20,4 CM - 8 IN<sup>7/16</sup>



**104480**  
**FOURCHETTE À GÂTEAUX/**  
**COCKTAIL**  
PASTRY/COCKTAIL FORK  
15 CM - 5 IN<sup>7/8</sup>



**104448**  
**CUILLÈRE À SOUPE ANGLAISE**  
BOUILLON SPOON, ROUND  
17,2 CM - 6 IN<sup>3/4</sup>



**104463**  
**FOURCHETTE À HÛÎTRES**  
OYSTER FORK  
12,9 CM - 5 IN<sup>1/8</sup>



**108236**  
**CUILLÈRE À DESSERT**  
DESSERT/SOUP SPOON, OVAL  
17,9 CM - 7 IN<sup>5/16</sup>



**195757**  
**FOURCHETTE DE SERVICE**  
SERVING FORK  
24,8 CM - 9 IN<sup>3/4</sup>



**108238**  
**FOURCHETTE À DESSERT**  
DESSERT/SALAD FORK  
17,8 CM - 7 IN



**195755**  
**CUILLÈRE DE SERVICE**  
SERVING SPOON  
25 CM - 9 IN<sup>13/16</sup>



**113019**  
**COUTEAU À DESSERT**  
**MONOBLOC LOURD**  
**LAME UNIE**  
DESSERT KNIFE HEAVY SOLID HANDLE  
21 CM - 8 IN<sup>1/4</sup>



**195750**  
**SERVICE À SALADE**  
SALAD SERVING SET  
25,7 CM - 10 IN<sup>5/8</sup>



**189971**  
**COUTEAU À BEURRE**  
**MONOBLOC LAME UNIE**  
BUTTER KNIFE SOLID HANDLE  
18,9 CM - 7 IN<sup>7/16</sup>



**195753**  
**PELLE À TARTE MONOBLOC**  
PASTRY SERVER SOLID HANDLE  
24,9 CM - 9 IN<sup>13/16</sup>



**104507**  
**FOURCHETTE POISSON**  
FISH FORK  
17,8 CM - 7 IN



**195762**  
**LOUCHE**  
SOUP LADLE  
29,8 CM - 11 IN<sup>3/4</sup>



**104508**  
**COUTEAU POISSON**  
FISH KNIFE  
19,7 CM - 7 IN<sup>3/4</sup>



**195759**  
**LOUCHE À SAUCE**  
SAUCE LADLE  
15,7 CM - 6 IN<sup>3/16</sup>

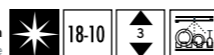

# MIKADO VINTAGE

All day dining



**230285**  
**FOURCHETTE DE TABLE**  
TABLE FORK  
20,3 CM - 8 IN



**230287**  
**COUTEAU DE TABLE**  
**MONOBLOC LOURD LAME SCIE**  
TABLE KNIFE HEAVY SOLID HANDLE SERRATED  
24,4 CM - 9 IN<sup>5/8</sup>



**230293**  
**COUTEAU À STEAK**  
**MONOBLOC LAME SCIE**  
STEAK KNIFE SOLID HANDLE SERRATED  
23,2 CM - 9 IN<sup>1/8</sup>



**230286**  
**CUILLÈRE DE TABLE**  
TABLE/PASTA SPOON  
20,4 CM - 8 IN<sup>1/16</sup>



**230291**  
**CUILLÈRE À DESSERT**  
DESSERT/SOUP SPOON, OVAL  
17,9 CM - 7 IN<sup>11/16</sup>



**230290**  
**FOURCHETTE À DESSERT**  
DESSERT/SALAD FORK  
17,8 CM - 7 IN



**230292**  
**COUTEAU À DESSERT**  
**MONOBLOC LOURD LAME UNIE**  
DESSERT KNIFE HEAVY SOLID HANDLE  
21 CM - 8 IN<sup>1/4</sup>



**230288**  
**CUILLÈRE À CAFÉ**  
COFFEE/TEA SPOON  
13,5 CM - 5 IN<sup>5/16</sup>



**230289**  
**CUILLÈRE À MOKA**  
DEMI TASSE SPOON  
11 CM - 4 IN<sup>1/16</sup>



Articles supplémentaires de qualité vintage disponibles sur demande  
Additional vintage quality items available upon request

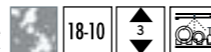

MILADY

Finedining

MADE IN FRANCE



**127442**  
**FOURCHETTE DE TABLE**  
TABLE FORK  
20,8 CM - 8 IN<sup>3/16</sup>



**226580**  
**COUTEAU À BEURRE**  
**MONOBLOC LOURD**  
**LAME UNIE**  
BUTTER KNIFE HEAVY SOLID HANDLE  
19 CM - 7 IN<sup>1/2</sup>



**226578**  
**COUTEAU DE TABLE**  
**MONOBLOC LOURD LAME SCIE**  
TABLE KNIFE HEAVY SOLID HANDLE SERRATED  
24,6 CM - 9 IN<sup>17/16</sup>



**122769**  
**COUTEAU À BEURRE**  
**MANCHE ORFÈVRE LAME UNIE**  
BUTTER KNIFE HOLLOW HANDLE  
18,7 CM - 7 IN<sup>3/8</sup>



**139158**  
**COUTEAU DE TABLE**  
**MANCHE ORFÈVRE LAME SCIE**  
TABLE KNIFE HOLLOW HANDLE SERRATED  
24,6 CM - 9 IN<sup>17/16</sup>



**127473**  
**FOURCHETTE À POISSON**  
FISH FORK  
17,7 CM - 6 IN<sup>15/16</sup>



**128841**  
**COUTEAU À STEAK**  
**MANCHE ORFÈVRE LAME SCIE**  
STEAK KNIFE HOLLOW HANDLE SERRATED  
23,9 CM - 9 IN<sup>7/16</sup>



**127477**  
**COUTEAU À POISSON**  
FISH KNIFE  
19,9 CM - 7 IN<sup>13/16</sup>



**127439**  
**CUILLÈRE DE TABLE**  
TABLE/PASTA SPOON  
20,8 CM - 8 IN<sup>3/16</sup>



**130542**  
**CUILLÈRE À SAUCE GOURMET**  
GOURMET/SAUCE SPOON  
17,9 CM - 7 IN<sup>1/16</sup>



**127464**  
**CUILLÈRE À DESSERT**  
DESSERT/SOUP SPOON, OVAL  
18 CM - 7 IN<sup>1/16</sup>



**127455**  
**CUILLÈRE À CAFÉ**  
COFFEE/TEA SPOON  
14 CM - 5 IN<sup>1/2</sup>



**127467**  
**FOURCHETTE À DESSERT**  
DESSERT/SALAD FORK  
17,8 CM - 7 IN



**127479**  
**CUILLÈRE À MOKA**  
DEMI TASSE SPOON  
11 CM - 4 IN<sup>5/16</sup>



**226579**  
**COUTEAU À DESSERT**  
**MONOBLOC LOURD LAME UNIE**  
DESSERT KNIFE HEAVY SOLID HANDLE  
21,1 CM - 8 IN<sup>5/16</sup>



**127482**  
**FOURCHETTE À GÂTEAUX/**  
**COCKTAIL**  
PASTRY/COCKTAIL FORK  
13,8 CM - 5 IN<sup>7/16</sup>



**127470**  
**COUTEAU À DESSERT**  
**MANCHE ORFÈVRE LAME UNIE**  
DESSERT KNIFE HOLLOW HANDLE  
20,5 CM - 8 IN<sup>1/16</sup>



**130266**  
**FOURCHETTE À HÛÎTRES**  
OYSTER FORK  
13 CM - 5 IN<sup>1/8</sup>

PIÈCES DE SERVICE  
SERVING PIECES

VERLAINE  
P. 156

ÉGALEMENT DISPONIBLE EN MÉTAL ARGENTÉ  
ALSO AVAILABLE IN SILVERPLATED FINISH



Possibilité de personnalisation  
Bespoke options available

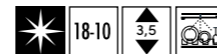



**105278**  
**FOURCHETTE DE TABLE**  
TABLE FORK  
20,8 CM - 8 IN<sup>3/16</sup>



**105274**  
**COUTEAU DE TABLE**  
**MANCHE ORFÈVRE LAME SCIE**  
TABLE KNIFE HOLLOW HANDLE SERRATED  
24,6 CM - 9 IN<sup>11/16</sup>



**105310**  
**CUILLÈRE DE TABLE**  
TABLE/PASTA SPOON  
20,8 CM - 8 IN<sup>3/16</sup>



**105294**  
**CUILLÈRE À DESSERT**  
DESSERT/SOUP SPOON, OVAL  
CUCHARA DE POSTRE  
18 CM - 7 IN<sup>1/16</sup>



**105290**  
**FOURCHETTE À DESSERT**  
DESSERT/SALAD FORK  
17,8 CM - 7 IN



**105305**  
**COUTEAU À DESSERT**  
**MANCHE ORFÈVRE LAME UNIE**  
DESSERT KNIFE HOLLOW HANDLE  
20,5 CM - 8 IN<sup>1/16</sup>



**105303**  
**CUILLÈRE À CAFÉ**  
COFFEE/TEA SPOON  
14 CM - 5 IN<sup>1/2</sup>



**105293**  
**CUILLÈRE À MOKA**  
DEMI TASSE SPOON  
11 CM - 4 IN<sup>5/16</sup>

**PIÈCES DE SERVICE**  
SERVING PIECES

**VERLAINE**  
**P. 156**

ÉGALEMENT DISPONIBLE EN MÉTAL ARGENTÉ  
ALSO AVAILABLE IN SILVERPLATED FINISH



Possibilité de personnalisation  
Bespoke options available

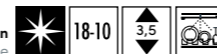

**NEUILLY**

Finedining

MADE IN FRANCE



©Patrick ROUGEREAU  
L'abus d'alcool est dangereux pour la santé  
Alcohol abuse is dangerous for your health

# NORMANDY

Finedining



**232963**  
**FOURCHETTE DE TABLE**  
TABLE FORK  
20,3 CM - 8 IN



**232966**  
**COUTEAU DE TABLE**  
**MONOBLOC LAME SCIE**  
TABLE KNIFE SOLID HANDLE SERRATED  
24 CM - 9 IN<sup>5/16</sup>

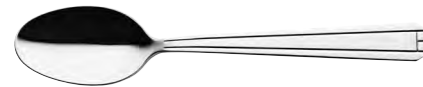

**232964**  
**CUILLÈRE DE TABLE**  
TABLE/PASTA SPOON  
20,3 CM - 8 IN



**234654**  
**CUILLÈRE À SOUPE ANGLAISE**  
BOUILLON SPOON  
17,6 CM - 6 IN<sup>15/16</sup>



**234659**  
**CUILLÈRE À DESSERT**  
DESSERT/SOUP SPOON, OVAL  
18,2 CM - 7 IN<sup>3/16</sup>



**234655**  
**CUILLÈRE GOURMET**  
GOURMET SPOON  
18,2 CM - 7 IN<sup>3/16</sup>



**234656**  
**FOURCHETTE À DESSERT/POISSON**  
DESSERT/SALAD/FISH FORK  
18,3 CM - 7 IN<sup>3/16</sup>



**239036**  
**COUTEAU À POISSON/SPATULE GOURMET**  
**MONOBLOC LAME UNIE**  
FISH KNIFE/GOURMET SPATULA  
20,5 CM - 8 IN<sup>1/16</sup>



**234657**  
**COUTEAU À DESSERT**  
**MONOBLOC LAME UNIE**  
DESSERT KNIFE SOLID HANDLE  
21,5 CM - 8 IN<sup>7/16</sup>



**234658**  
**COUTEAU À BEURRE**  
**MONOBLOC LAME UNIE**  
BUTTER KNIFE SOLID HANDLE  
18,5 CM - 7 IN<sup>5/16</sup>



**232965**  
**CUILLÈRE À CAFÉ**  
COFFEE/TEA SPOON  
14 CM - 5 IN<sup>1/2</sup>



**234660**  
**CUILLÈRE À MOKA**  
DEMI TASSE SPOON  
11,1 CM - 4 IN<sup>3/8</sup>



**234661**  
**FOURCHETTE À GÂTEAUX/COCKTAIL**  
PASTRY/COCKTAIL FORK  
14 CM - 5 IN<sup>1/2</sup>

EGALEMENT DISPONIBLE EN MÉTAL ARGENTÉ  
ALSO AVAILABLE IN SILVERPLATED FINISH



Possibilité de personnalisation  
Bespoke options available

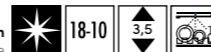



VERLAINE

Finedining

MADE IN FRANCE



**105831  
FOURCHETTE DE TABLE**  
TABLE FORK  
20,8 CM - 8 IN<sup>3/16</sup>



**182460  
COUTEAU DE TABLE  
MONOBLOC LOURD LAME SCIE**  
TABLE KNIFE HEAVY SOLID HANDLE  
SERRATED  
24,6 CM - 9 IN<sup>17/16</sup>



**105886  
COUTEAU DE TABLE  
MANCHE ORFÈVRE DROIT LAME UNIE**  
TABLE KNIFE HOLLOW HANDLE  
24,6 CM - 9 IN<sup>17/16</sup>



**105860  
COUTEAU DE TABLE  
MANCHE ORFÈVRE DROIT LAME SCIE**  
TABLE KNIFE HOLLOW HANDLE SERRATED  
24,6 CM - 9 IN<sup>17/16</sup>



**105801  
COUTEAU À STEAK  
MANCHE ORFÈVRE LAME SCIE**  
STEAK KNIFE HOLLOW HANDLE SERRATED  
23,9 CM - 9 IN<sup>7/16</sup>



**105798  
CUILLÈRE DE TABLE**  
TABLE/PASTA SPOON  
20,8 CM - 8 IN<sup>3/16</sup>



**105908  
CUILLÈRE À SOUPE ANGLAISE**  
BOUILLON SPOON, ROUND  
17,2 CM - 6 IN<sup>3/4</sup>



**105861  
CUILLÈRE À DESSERT**  
DESSERT/SOUP SPOON, OVAL  
18 CM - 7 IN<sup>1/16</sup>



**105885  
FOURCHETTE À DESSERT**  
DESSERT/SALAD FORK  
17,8 CM - 7 IN



**182463  
COUTEAU À DESSERT  
MONOBLOC LOURD LAME UNIE**  
DESSERT KNIFE HEAVY SOLID HANDLE  
21,1 CM - 8 IN<sup>5/16</sup>



**105832  
COUTEAU À DESSERT  
MANCHE ORFÈVRE  
LAME UNIE**  
DESSERT KNIFE HOLLOW HANDLE  
20,5 CM - 8 IN<sup>7/16</sup>



**190420  
COUTEAU À BEURRE  
MONOBLOC LOURD  
LAME UNIE**  
BUTTER KNIFE HEAVY SOLID HANDLE  
19 CM - 7 IN<sup>1/2</sup>



**003332  
COUTEAU À BEURRE  
MANCHE ORFÈVRE  
LAME UNIE**  
BUTTER KNIFE HOLLOW HANDLE  
18,7 CM - 7 IN<sup>3/8</sup>



**105888  
FOURCHETTE À POISSON**  
FISH FORK  
17,8 CM - 7 IN



**105797  
COUTEAU À POISSON**  
FISH KNIFE  
19,7 CM - 7 IN<sup>3/4</sup>



**105910  
CUILLÈRE À SAUCE GOURMET**  
GOURMET/SAUCE SPOON  
17,9 CM - 7 IN<sup>11/16</sup>



**105833  
CUILLÈRE À CAFÉ**  
COFFEE/TEA SPOON  
14 CM - 5 IN<sup>1/2</sup>



**109471  
CUILLÈRE À MOKA**  
DEMI TASSE SPOON  
11 CM - 4 IN<sup>5/16</sup>



**105800  
CUILLÈRE À SODA**  
ICED TEA SPOON  
18,2 CM - 7 IN<sup>3/16</sup>



**105795  
FOURCHETTE À GÂTEAUX/  
COCKTAIL**  
PASTRY/COCKTAIL FORK  
13,8 CM - 5 IN<sup>7/16</sup>



**105907  
FOURCHETTE À HUITRES**  
OYSTER FORK  
12,9 CM - 5 IN<sup>1/16</sup>



**132782  
FOURCHETTE À ESCARGOTS**  
SNAIL FORK  
13,5 CM - 5 IN<sup>3/16</sup>



**003390  
COUTEAU À FROMAGES  
MANCHE ORFÈVRE LAME UNIE**  
CHEESE KNIFE HOLLOW HANDLE  
19,3 CM - 7 IN<sup>11/16</sup>



**002185  
FOURCHETTE DE SERVICE**  
SERVING FORK  
24,8 CM - 9 IN<sup>3/4</sup>



**002186  
CUILLÈRE DE SERVICE**  
SERVING SPOON  
25 CM - 9 IN<sup>13/16</sup>



**040646  
SERVICE À SALADE**  
SALADE SERVING SET  
25,8 CM - 10 IN<sup>3/16</sup>



**083340  
PELLE À TARTE MONOBLOC**  
PASTRY SERVER SOLID HANDLE  
24,9 CM - 9 IN<sup>13/16</sup>



**097717  
LOUCHE**  
SOUP LADLE  
29,8 CM - 11 IN<sup>3/4</sup>



**002179  
LOUCHE À SAUCE**  
SAUCE LADLE  
15,7 CM - 6 IN<sup>3/16</sup>



EGALEMENT DISPONIBLE EN MÉTAL ARGENTÉ  
ALSO AVAILABLE IN SILVERPLATED FINISH





Possibilité de personnalisation  
Bespoke options available



# VIEUX PARIS

Alldaydining

- **105804**  
**FOURCHETTE DE TABLE**  
TABLE FORK  
21 CM - 8 IN<sup>1/4</sup>
- **105892**  
**COUTEAU DE TABLE**  
**MONOBLOC LAME SCIE**  
TABLE KNIFE SOLID HANDLE  
SERRATED  
25 CM - 9 IN<sup>13/16</sup>
- **160424**  
**COUTEAU À STEAK**  
**MONOBLOC LAME SCIE**  
STEAK KNIFE SOLID HANDLE SERRATED  
23,2 CM - 9 IN<sup>1/8</sup>
- **105911**  
**CUILLÈRE DE TABLE**  
TABLE/PASTA SPOON  
21 CM - 8 IN<sup>1/4</sup>
- **105863**  
**CUILLÈRE À DESSERT**  
DESSERT/SOUP SPOON, OVAL  
18 CM - 7 IN<sup>1/8</sup>
- **105890**  
**FOURCHETTE À DESSERT**  
DESSERT/SALAD FORK  
18 CM - 7 IN<sup>1/8</sup>
- **210626**  
**COUTEAU À DESSERT**  
**MONOBLOC LAME SCIE**  
DESSERT KNIFE SOLID HANDLE SERRATED  
20,7 CM - 8 IN<sup>1/8</sup>
- **105837**  
**FOURCHETTE À POISSON**  
FISH FORK  
18 CM - 7 IN<sup>1/8</sup>
- **105912**  
**COUTEAU À POISSON**  
FISH KNIFE  
20 CM - 7 IN<sup>7/8</sup>
- **105838**  
**CUILLÈRE À CAFÉ**  
COFFEE/TEA SPOON  
14,1 CM - 5 IN<sup>9/16</sup>
- **105891**  
**CUILLÈRE À MOKA**  
DEMI TASSE SPOON  
11 CM - 4 IN<sup>5/16</sup>
- **105805**  
**FOURCHETTE À GÂTEAUX/**  
**COCKTAIL**  
PASTRY/COCKTAIL FORK  
13,9 CM - 5 IN<sup>1/2</sup>
- **105803\***  
**FOURCHETTE À HUÎTRES**  
OYSTER FORK  
13,2 CM - 5 IN<sup>1/16</sup>
- **000490**  
**FOURCHETTE DE SERVICE**  
SERVING FORK  
24,6 CM - 9 IN<sup>11/16</sup>
- **000491**  
**CUILLÈRE DE SERVICE**  
SERVING SPOON  
24,9 CM - 9 IN<sup>13/16</sup>

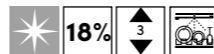



*P* I È C E S  
C O M P L É M E N T A I R E S  
A D D I T I O N N A L P I E C E S

## MIRAGE LES ESSENCES



**243524**  
**COUTEAU À STEAK LAME UNIE MANCHE OLIVIER**  
STEAK KNIFE SOLID HANDLE OLIVE WOOD HANDLE  
23 CM - 9 IN<sup>7/16</sup>



**243528**  
**COUTEAU À STEAK LAME UNIE MANCHE PICANA**  
STEAK KNIFE SOLID HANDLE PICANA HANDLE  
23 CM - 9 IN<sup>7/16</sup>



**243525**  
**COUTEAU À STEAK LAME UNIE MANCHE ÉBÈNE**  
STEAK KNIFE SOLID HANDLE EBONY HANDLE  
23 CM - 9 IN<sup>7/16</sup>

**MANCHES EN BOIS VÉRITABLE**  
GENUINE WOODEN HANDLES



## MIRAGE



**226261**  
**COUTEAU DE TABLE/ STEAK LAME UNIE ANTHRACITE**  
BLACK TABLE STEAK KNIFE  
23 CM - 9 IN<sup>7/16</sup>



**226263**  
**COUTEAU DE TABLE/ STEAK LAME UNIE BLANC**  
WHITE TABLE STEAK KNIFE  
23 CM - 9 IN<sup>7/16</sup>

## LE PHIL



**246174**  
**COUTEAU À STEAK MONOBLOC LAME UNIE NEW**  
STEAK KNIFE SOLID HANDLE  
23,7 CM - 9 IN<sup>5/16</sup>

## COUTEAUX ORFÈVRE - HOLLOW HANDLE



**122759**  
**COUTEAU À STEAK MANCHE ORFÈVRE LAME SCIE BLOIS**  
BLOIS STEAK KNIFE HOLLOW HANDLE SERRATED  
23,9 CM - 9 IN<sup>7/16</sup>



**127654**  
**COUTEAU À STEAK MANCHE ORFÈVRE LAME SCIE FLORENCIA**  
FLORENCIA STEAK KNIFE HOLLOW HANDLE SERRATED  
23,9 CM - 9 IN<sup>7/16</sup>



**122746**  
**COUTEAU À STEAK MANCHE ORFÈVRE LAME SCIE LUTECE**  
LUTECE STEAK KNIFE HOLLOW HANDLE SERRATED  
23,8 CM - 9 IN<sup>3/16</sup>



**186278**  
**COUTEAU À STEAK MANCHE ORFÈVRE LAME SCIE MARQUISE**  
MARQUISE STEAK KNIFE HOLLOW HANDLE SERRATED  
23,9 CM - 9 IN<sup>7/16</sup>



**128841**  
**COUTEAU À STEAK MANCHE ORFÈVRE LAME SCIE MILADY**  
MILADY STEAK KNIFE HOLLOW HANDLE SERRATED  
23,9 CM - 9 IN<sup>7/16</sup>



**105801**  
**COUTEAU À STEAK MANCHE ORFÈVRE LAME SCIE VERLAINE**  
VERLAINE STEAK KNIFE HOLLOW HANDLE SERRATED  
23,9 CM - 9 IN<sup>7/16</sup>

## COUTEAUX STEAK

MADE IN FRANCE



# COUTEAUX STEAK

Steak knives



**199761**  
**COUTEAU À STEAK MONOBLOC LAME SCIE ASTRÉE CISELÉ**  
ASTREE CISELÉ STEAK KNIFE SOLID HANDLE SERRATED  
22,8 CM - 9 IN



**160433**  
**COUTEAU À STEAK MONOBLOC LAME SCIE CONFIDENCE**  
CONFIDENCE STEAK KNIFE SOLID HANDLE SERRATED  
23,6 CM - 9 IN<sup>5/16</sup>



**159451**  
**COUTEAU À STEAK MONOBLOC LAME SCIE GOURMET**  
GOURMET STEAK KNIFE SOLID HANDLE SERRATED  
23,5 CM - 9 IN<sup>1/4</sup>



**197521**  
**COUTEAU À STEAK MONOBLOC LAME SCIE GUEST**  
GUEST STEAK KNIFE SOLID HANDLE SERRATED  
23,2 CM - 9 IN<sup>9/16</sup>



**203017**  
**COUTEAU À STEAK MONOBLOC LAME SCIE GUEST STAR**  
GUEST STAR STEAK KNIFE SOLID HANDLE SERRATED  
23,2 CM - 9 IN<sup>9/16</sup>



**230339**  
**COUTEAU À STEAK MONOBLOC LAME SCIE GUEST VINTAGE**  
GUEST VINTAGE STEAK KNIFE SOLID HANDLE SERRATED  
23,2 CM - 9 IN<sup>9/16</sup>



**160427**  
**COUTEAU À STEAK MONOBLOC LAME SCIE MIKADO**  
MIKADO STEAK KNIFE SOLID HANDLE SERRATED  
23,2 CM - 9 IN<sup>9/16</sup>



**230293**  
**COUTEAU À STEAK MONOBLOC LAME SCIE MIKADO VINTAGE**  
MIKADO VINTAGE STEAK KNIFE SOLID HANDLE SERRATED  
23,2 CM - 9 IN<sup>9/16</sup>



**160424**  
**COUTEAU À STEAK MONOBLOC LAME SCIE VIEUX PARIS**  
VIEUX PARIS STEAK KNIFE SOLID HANDLE SERRATED  
23,2 CM - 9 IN<sup>9/16</sup>



L'abus d'alcool est dangereux pour la santé  
Alcohol abuse is dangerous for your health

# PIÈCES COMPLÉMENTAIRES

Additional pieces



**190018  
CUILLÈRE À SODA**  
ICED TEA SPOON  
19 CM - 7 IN<sup>1/2</sup>



**189973  
CUILLÈRE À SODA**  
ICED TEA SPOON  
19 CM - 7 IN<sup>1/2</sup>



**226175\*  
CUILLÈRE À SODA**  
ICED TEA SPOON  
19 CM - 7 IN<sup>1/2</sup>



**162724  
CUILLÈRE À AGRUMES**  
CITRUS FRUITS SPOON  
15,3 CM - 6 IN



**190424  
FOURCHETTE À HUITRES**  
OYSTER FORK  
14,1 CM - 5 IN<sup>3/16</sup>



**189974  
FOURCHETTE À HUITRES**  
OYSTER FORK  
14,1 CM - 5 IN<sup>3/16</sup>



**105803\*  
FOURCHETTE À HUITRES**  
OYSTER FORK  
13,2 CM - 5 IN<sup>3/16</sup>



**162728  
FOURCHETTE/PIQUE À  
ESCARGOTS/COCKTAIL**  
COCKTAIL, SNAIL FORK  
10,8 CM - 4 IN<sup>1/4</sup>



**162730  
CURETTE À CRUSTACÉS**  
SEAFOOD SCRAPER  
19,1 CM - 7 IN<sup>1/2</sup>



**189971  
COUPEAU À BEURRE  
MONOBLOC LAME UNIE**  
BUTTER KNIFE SOLID HANDLE  
18,9 CM - 7 IN<sup>7/16</sup>



**159451  
COUPEAU À STEAK  
MONOBLOC LAME SCIE**  
STEAK KNIFE SOLID HANDLE SERRATED  
23,5 CM - 9 IN<sup>1/4</sup>



**181112  
TARTINEUR**  
BUTTER SPREADER  
16 CM - 6 IN<sup>5/16</sup>



**197522  
FOURCHETTE DE SERVICE**  
SERVING FORK  
26,6 CM - 10 IN<sup>1/2</sup>



**197523  
CUILLÈRE DE SERVICE**  
SERVING SPOON  
27 CM - 10 IN<sup>5/8</sup>



**197525  
SERVICE À SALADE**  
SALAD SERVING SET  
30 CM - 11 IN<sup>13/16</sup>



**197527  
PELLE À TARTE MONOBLOC**  
PASTRY SERVER SOLID HANDLE  
25,1 CM - 9 IN<sup>7/16</sup>



**153193  
LOUCHE**  
SOUP LADLE  
28,8 CM - 11 IN<sup>5/16</sup>



**154606  
CUILLÈRE À SAUCE**  
SAUCE LADLE  
18,5 CM - 7 IN<sup>5/16</sup>



**184492  
PINCE À CRUSTACÉ**  
SEAFOOD CRACKER  
16,5 CM - 6 IN<sup>1/2</sup>



**004013  
PINCE À ESCARGOTS**  
SNAIL TONG  
16 CM - 6 IN<sup>5/16</sup>



**204498  
PINCE À PAIN**  
BREAD TONG  
23 CM - 9 IN<sup>1/16</sup>



**204496  
CISEAUX À GÂTEAUX**  
PASTRY CISSORS/TONG  
20 CM - 7 IN<sup>7/16</sup>



**204499  
PINCE À SERVIR**  
SERVING TONG  
29,5 CM - 11 IN<sup>5/8</sup>

## VERLAINE



**105795  
FOURCHETTE À GÂTEAUX/  
COCKTAIL**  
PASTRY/COCKTAIL FORK  
13,8 CM - 5 IN<sup>7/16</sup>



**105907  
FOURCHETTE  
À HUITRES**  
OYSTER FORK  
12,9 CM - 5 IN<sup>1/16</sup>



**132782  
FOURCHETTE  
À ESCARGOTS**  
SNAIL FORK



**002185  
FOURCHETTE  
DE SERVICE**  
SERVING FORK  
24,8 CM - 9 IN<sup>3/4</sup>



**002186  
CUILLÈRE  
DE SERVICE**  
SERVING SPOON  
25 CM - 9 IN<sup>13/16</sup>



**040646  
SERVICE  
À SALADE**  
SALAD SERVING SET  
25,8 CM - 10 IN<sup>3/16</sup>



**083340  
PELLE À TARTE  
MONOBLOC**  
PASTRY SERVER  
SOLID HANDLE  
24,9 CM - 9 IN<sup>15/16</sup>



**097717  
LOUCHE**  
SOUP LADLE  
29,8 CM - 11 IN<sup>3/4</sup>



**002179  
LOUCHE À SAUCE**  
SAUCE LADLE  
15,7 CM - 6 IN<sup>3/16</sup>

## BLOIS



**104480  
FOURCHETTE À GÂTEAUX/  
COCKTAIL**  
PASTRY/COCKTAIL FORK  
13,8 CM - 5 IN<sup>7/16</sup>



**104463  
FOURCHETTE À HUITRES**  
OYSTER FORK  
12,9 CM - 5 IN<sup>1/16</sup>



**195757  
FOURCHETTE DE SERVICE**  
SERVING FORK  
24,8 CM - 9 IN<sup>3/4</sup>



**195755  
CUILLÈRE DE SERVICE**  
SERVING SPOON  
25 CM - 9 IN<sup>13/16</sup>



**195757  
FOURCHETTE À DÉCOUPER**  
CARVING FORK  
24,8 CM - 9 IN<sup>3/4</sup>



**189511  
COUPEAU À DÉCOUPER  
MANCHE ORFÈVRE LAME UNIE**  
CARVING KNIFE HOLLOW HANDLE  
28,7 CM - 11 IN<sup>5/16</sup>



**195750  
SERVICE À SALADE**  
SALAD SERVING SET  
25,7 CM - 10 IN<sup>1/8</sup>



**195753  
PELLE À TARTE MONOBLOC**  
PASTRY SERVER SOLID HANDLE  
24,9 CM - 9 IN<sup>15/16</sup>



**195762  
LOUCHE**  
SOUP LADLE  
29,8 CM - 11 IN<sup>3/4</sup>



**195759  
LOUCHE À SAUCE**  
SAUCE LADLE  
15,7 CM - 6 IN<sup>3/16</sup>

# PETIT GOURMET

All day dining



207257  
**FOURCHETTE À DESSERT**  
DESSERT/SALAD FORK  
16,5 CM - 6 IN<sup>1/2</sup>



207259  
**COUTEAU À DESSERT**  
**MONOBLOC LAME UNIE**  
DESSERT KNIFE SOLID HANDLE  
17,7 CM - 6 IN<sup>5/8</sup>



207258  
**CUILLÈRE À DESSERT**  
DESSERT/SOUP SPOON, OVAL  
16,5 CM - 6 IN<sup>1/2</sup>



207256  
**CUILLÈRE À CAFÉ**  
COFFEE/TEA SPOON  
13,2 CM - 5 IN<sup>3/8</sup>





A  
P L A T E R I E  
H O L L O W A R E

A travers des objets en acier dédiés à la table, au service et à la dégustation, DEGRENNE exprime à travers ses collections de platerie toute la richesse de son métier d'orfèvre.

DEGRENNE expresses its highly-varied metal-working expertise through steel products designed for the table, service and tasting and appreciating.



# NEWPORT PLATEAUX

Finedining



  
DEGRENNE  
PARIS

## NEWPORT

PLATEAUX EMPILABLES STACKABLE SERVING TRAYS



- PLATEAUX RECTANGULAIRES AVEC ANSES**  
RECTANGULAR SERVING TRAYS WITH HANDLES
- **238953**  
■ **238963**  
EXT : 77 X 55 CM - 30 IN<sup>5/16</sup> X 21 IN<sup>5/8</sup>  
INT : 68,5 X 46,5 CM - 26 IN<sup>15/16</sup> X 18 IN<sup>5/16</sup>
  - **238954**  
■ **238964**  
GASTRONORM 2/1  
EXT : 65 X 53 CM - 25 IN<sup>9/16</sup> X 20 IN<sup>7/8</sup>  
INT : 56,5 X 44,5 CM - 22 IN<sup>1/4</sup> X 17 IN<sup>1/2</sup>
  - **238955**  
■ **238965**  
EXT : 60 X 40 CM - 23 IN<sup>5/8</sup> X 15 IN<sup>3/4</sup>  
INT : 51,5 X 31,5 CM - 20 IN<sup>1/4</sup> X 12 IN<sup>3/8</sup>



- PLATEAU ROND**  
ROUND TRAY
- **185024**  
■ **186457**  
EXT : 42 CM - 16 IN<sup>9/16</sup>  
INT : 35,1 CM - 13 IN<sup>13/16</sup>



- PLATEAUX RECTANGULAIRES SANS ANSES**  
RECTANGULAR SERVING TRAYS WITHOUT HANDLES
- **238962**  
■ **238970**  
GASTRONORM 1/1  
EXT : 53 X 32,5 CM - 20 IN<sup>7/8</sup> X 12 IN<sup>13/16</sup>  
INT : 46,5 X 26 CM - 18 IN<sup>5/16</sup> X 10 IN<sup>1/4</sup>
  - **185020**  
■ **238971**  
EXT : 40 X 27 CM - 15 IN<sup>3/4</sup> X 10 IN<sup>5/8</sup>  
INT : 33,5 X 20,5 CM - 13 IN<sup>3/16</sup> X 8 IN<sup>1/16</sup>
  - **238960**  
■ **238972**  
GASTRONORM 1/2  
EXT : 32,5 X 26,5 CM - 12 IN<sup>13/16</sup> X 10 IN<sup>7/16</sup>  
INT : 26 X 20 CM - 10 IN<sup>1/4</sup> X 7 IN<sup>7/8</sup>
  - **227767**  
■ **227768**  
EXT : 22 X 14 CM - 8 IN<sup>11/16</sup> X 5 IN<sup>1/2</sup>  
INT : 20 X 12 CM - 7 IN<sup>7/8</sup> X 4 IN<sup>3/4</sup>

## NORMANDY



- PLATEAU RECTANGULAIRE SANS ANSES**  
RECTANGULAR SERVING TRAY WITHOUT HANDLES
- **232972**  
INT : 26 X 18 CM - 10 IN<sup>1/4</sup> X 7 IN<sup>1/16</sup>  
EXT : 23 X 15 CM - 9 IN<sup>1/16</sup> X 5 IN<sup>7/8</sup>

## NEWPORT CUBIQUE

PLATEAUX EMPILABLES STACKABLE SERVING TRAYS



- PLATEAUX RECTANGULAIRES AVEC ANSES**  
RECTANGULAR SERVING TRAYS WITH HANDLES
- **211886**  
■ **238989**  
GASTRONORM 2/1  
EXT : 65 X 53 CM - 25 IN<sup>9/16</sup> X 20 IN<sup>7/8</sup>  
INT : 56,5 X 44,5 CM - 22 IN<sup>1/4</sup> X 17 IN<sup>1/2</sup>
  - **211887**  
■ **238990**  
EXT : 60 X 40 CM - 23 IN<sup>5/8</sup> X 15 IN<sup>3/4</sup>  
INT : 51,5 X 31,5 CM - 20 IN<sup>1/4</sup> X 12 IN<sup>3/8</sup>



- PLATEAUX RECTANGULAIRES SANS ANSES**  
RECTANGULAR SERVING TRAYS WITHOUT HANDLES
- **238990**  
■ **213859**  
GASTRONORM 1/2  
EXT : 32,5 X 26,5 CM - 12 IN<sup>13/16</sup> X 10 IN<sup>7/16</sup>  
INT : 26 X 20 CM - 10 IN<sup>1/4</sup> X 7 IN<sup>7/8</sup>
  - **211889**  
■ **213860**  
EXT : 22 X 14 CM - 8 IN<sup>11/16</sup> X 5 IN<sup>1/2</sup>  
INT : 20 X 12 CM - 7 IN<sup>7/8</sup> X 4 IN<sup>3/4</sup>



- DESSOUS DE BOUTEILLE**  
BOTTLE COASTER
- **230872**  
■ **230874**  
13,5 CM - 5 IN<sup>5/16</sup>





**PLATS OVALES**  
OVAL DISHES

**238958**  
**238968**

EXT : 46 X 31 CM - 18 IN<sup>1/8</sup> X 12 IN<sup>3/16</sup>  
INT : 25,9 X 13,9 CM - 10 IN<sup>3/16</sup> X 5 IN<sup>1/2</sup>

**238957**  
**238967**

EXT : 41 X 28 CM - 16 IN<sup>1/8</sup> X 11 IN  
INT : 28,7 X 15,6 CM - 11 IN<sup>5/16</sup> X 6 IN<sup>1/8</sup>

**238956**  
**238966**

EXT : 38 X 25 CM - 14 IN<sup>15/16</sup> X 9 IN<sup>13/16</sup>  
INT : 26,6 X 16,3 CM - 10 IN<sup>1/2</sup> X 6 IN<sup>7/16</sup>



**PLAT À POISSON**  
FISH DISH

**238959**  
**238969**

INT : 60 X 27 CM - 23 IN<sup>15/8</sup> X 10 IN<sup>5/8</sup>  
EXT : 46,3 X 14,3 CM - 18 IN<sup>1/4</sup> X 5 IN<sup>5/8</sup>



**SAUCIÈRE**  
SAUCE BOAT

**186198**  
**186456**

19 X 7,6 CM - 20 CL  
7 IN<sup>1/2</sup> X 3 IN - 6 OZ<sup>3/4</sup>



**BEURRIER**  
BUTTER DISH

**185307**  
**186455**

Ø 7,6 X 7 CM - 3 IN<sup>5/8</sup> X 2 IN<sup>3/4</sup>



**PORTE SUCRE**  
CENTRE DE TABLE  
SUGAR HOLDER/TABLE

**211397**

Ø 6,4 X H 6 CM - Ø 2 IN<sup>1/2</sup> X H 2 IN<sup>3/8</sup>



**SOCLE BEURRIER**  
PORCELAINE  
BUTTER DISH  
BASE PORCELAIN

**190255**

Ø 9 X 7,6 CM - 3 IN X 2 IN<sup>3/4</sup>

# NEWPORT TABLE

Finedining

MADE IN FRANCE



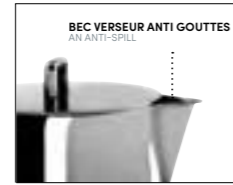

**VERSEUSES**  
COFFEE/TEA POTS

★ **213850**  
☑ **219563**  
1,5 L - 18,1 CM X H 22,4 CM  
50 OZ<sup>3/4</sup> - 7 IN<sup>1/8</sup> X H 8 IN<sup>3/16</sup>

★ **213851**  
☑ **219564**  
70 CL - 14,8 CM X H 14,6 CM  
23 OZ<sup>1/16</sup> - 5 IN<sup>13/16</sup> X H 5 IN<sup>3/4</sup>

★ **213852**  
☑ **219565**  
35 CL - 12,9 CM X H 9,3 CM  
11 OZ<sup>13/16</sup> - 5 IN<sup>1/16</sup> X H 3 IN<sup>11/16</sup>



**POTS ISOTHERMES**  
INSULATED POTS

★ **213846**  
☑ **219557**  
1,2 L - 18,1 CM X H 22,7 CM  
40 OZ<sup>9/16</sup> - 7 IN<sup>1/8</sup> X H 8 IN<sup>15/16</sup>

★ **213847**  
☑ **219558**  
70 CL - 15,6 CM X H 19,2 CM  
23 OZ<sup>1/16</sup> - 6 IN<sup>1/8</sup> X H 7 IN<sup>9/16</sup>

★ **213848**  
☑ **219559**  
30 CL - 13,4 CM X H 12,7 CM  
40 OZ - 5 IN<sup>1/4</sup> X H 5 IN



**SUCRIER** ★ **182341**  
SUGAR BOWL ☑ **184612**  
35 CL  
11 OZ<sup>13/16</sup>



**PICHET** ★ **213849**  
JUG ☑ **219561**  
2 L - 18,1 CM X H 23 CM  
67 OZ<sup>2/8</sup> - 7 IN<sup>1/8</sup> X H 9 IN<sup>1/16</sup>



**CRÉMIERS** ★ **213853**  
CREAM JUGS ☑ **219566**  
35 CL - 12,9 CM X H 9 CM  
11 OZ<sup>13/16</sup> - 5 IN<sup>1/16</sup> X H 3 IN<sup>9/16</sup>

★ **213854**  
☑ **219567**  
15 CL - 9 CM X H 9 CM  
5 OZ<sup>1/16</sup> - 3 IN<sup>9/16</sup> X H 3 IN<sup>9/16</sup>



**NEWPORT**  
P. 80



# NEWPORT BAR

All day dining



**SEAU À CHAMPAGNE** ■ 184180  
**2 BOUTEILLES** ■ 188895  
CHAMPAGNE BUCKET Ø 24 X H 25,5 CM  
2 BOTTLES Ø 9 IN<sup>7/16</sup> X H 10 IN<sup>1/16</sup>

**SEAU À CHAMPAGNE** ■ 186030  
**1 BOUTEILLE** ■ 188894  
CHAMPAGNE BUCKET Ø 20 X H 22,5 CM  
1 BOTTLE Ø 7 IN<sup>7/8</sup> X H 8 IN<sup>7/8</sup>



**SEAU À GLACE** ■ 184181  
**AVEC COUVERCLE** ■ 188896  
ICE BUCKET WITH LID Ø 15 X H 16 CM  
Ø 5 IN<sup>7/8</sup> X H 6 IN<sup>5/16</sup>



**RAFRAICHISSEUR** ■ 237501  
**DROIT DOUBLE PAROI**  
CURVED DOUBLE WALL WINE COOLER  
Ø 13,9 X H 19,8 CM  
Ø 5 IN<sup>7/8</sup> X H 7 IN<sup>13/16</sup>



**DESSOUS DE BOUTEILLE** ■ 234320  
BOTTLE COASTER  
NEWPORT LOUNGE  
9,5 CM - 3 IN<sup>3/4</sup>



**PORTE SEAU** ■ 185607  
**À CHAMPAGNE** ■ 188893  
**(1 OU 2 BOUTEILLES)**  
CHAMPAGNE BUCKET STAND  
(1 OR 2 BOTTLES) H 63,5 CM - 25 IN



**PINCE À GLACE** ■ 004014  
ICE TONG 16 CM  
6 IN<sup>5/16</sup>



# NEWPORT ACCESSOIRES

Alldaydining

MADE IN EUROPE



**CLOCHE** INOX  
**ASSIETTE** STAINLESS STEEL  
DOME COVER  
# 182614  
# 184477  
Ø 24 CM - 9 IN<sup>7/16</sup>

---

# 182301  
# 184476  
Ø 14,8 CM - 5 IN<sup>13/16</sup>



**INOX**  
STAINLESS STEEL  
# 044113  
# 101512  
Ø 26 CM - 10 IN<sup>1/4</sup>

---

# 044112  
# 101510  
22 CM - 8 IN<sup>7/8</sup>



**CLOCHE** 239771  
**EVENTO** Ø 28 CM - 11 IN  
**VERRE**  
**EVENTO** 239770  
DOME COVER  
Ø 23 CM - 9 IN<sup>1/8</sup>  
239769  
Ø 16 CM - 6 IN<sup>5/16</sup>



**VERRE BOROSILICATE**  
GLASS  
204043  
17 X 9 CM - 6 IN<sup>11/16</sup> X 3 IN<sup>9/16</sup>

---

206504  
**BOUCHON PORCELAINE**  
PORCELAIN LID  
5,2 CM - 2 IN<sup>1/16</sup>



**CORBILLE RONDE**  
**À PAIN** ROUND  
BREAD BASKET # 128910  
# 131114  
Ø 17,5 X H 6 CM  
Ø 6 IN<sup>7/8</sup> X H 2 IN<sup>3/8</sup>

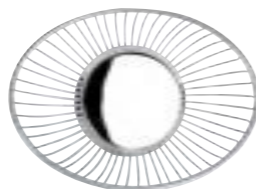

**CORBILLE OVALE**  
**À PAIN** OVAL  
BREAD BASKET # 128912  
# 131117  
Ø 24 X 17 CM - H 7,5 CM  
Ø 9 IN<sup>7/16</sup> X 6 IN<sup>11/16</sup> - H 2 IN<sup>5/16</sup>

---

# 128911  
# 131118  
Ø 20 X 15 CM - H 6 CM  
Ø 7 IN<sup>7/8</sup> X 5 IN<sup>7/8</sup> - H 2 IN<sup>3/8</sup>



**VERRINE** 216920 ••  
**SEL/POIVRE** POIVRE/PEPPER  
**AIMANTÉE**  
SALT & PEPPER  
CELLAR W/MAGNET  
216919 •••  
**SEL/SALT**  
# 4,1 X 6,7 CM  
1 IN<sup>5/8</sup> X 2 IN<sup>5/8</sup>



**PLAT** 164138  
**À ESCARGOTS** PORCELAINE  
SNAIL TONG PORCELAIN  
Ø 16,6 CM - 6 IN<sup>5/16</sup>



**ENSEMBLE** 216922  
**SEL/POIVRE** 8,5 X 10,6 CM  
**AIMANTÉE** 3 IN<sup>3/8</sup> X 4 IN<sup>3/16</sup>  
SALT & PEPPER  
CELLAR W/MAGNET



**PINCE** # 004013  
**À ESCARGOTS** 16 CM - 6 IN<sup>5/16</sup>  
SNAIL TONG



**CISEAUX À** # 204496  
**GÂTEAUX** # 101494  
PASTRY 20 CM - 7 IN<sup>7/8</sup>  
SCISSORS/TONG



**PINCE À PAIN** # 204498  
BREAD TONG # 101492  
23 CM - 9 IN<sup>1/16</sup>



**PINCE** # 184492  
**À CRUSTACÉS** 16,5 CM - 6 IN<sup>1/2</sup>  
SEAFOOD/CRAKER



**PINCE À SERVIR** # 204499  
SERVING TONG # 184355  
29,5 CM - 11 IN<sup>5/8</sup>





# L

ES  
VERRES  
GLASSWARE

Les collections de verres DEGRENNE invitent au partage et à la dégustation. Leurs qualités esthétiques ainsi que leur résistance exceptionnelle, garantissent une utilisation en toute occasion. Pour compléter harmonieusement la table, les verres de couleur DEGRENNE, teintés dans la masse, offrent une esthétique et une qualité à l'épreuve du temps et des lavages au lave-vaisselle.

DEGRENNE'S glassware collections are an invitation to socialize and enjoy a drink. Our glassware's looks and exceptional sturdiness mean that is suitable for any occasion. DEGRENNE's integrally dyed glasses are a harmonious addition to the dining table and offer looks and quality that withstand the test of time and repeated washing in the dishwasher.



**FLÛTE 242793**  
**À CHAMPAGNE** 26,1 CL  
 CHAMPAGNE 8 OZ<sup>53/64</sup>  
 FLUTE Ø 7,25 CM  
 H 24,5 CM  
 Ø 2 IN<sup>55/64</sup>  
 H 9 IN<sup>41/64</sup>



**VERRE 242792**  
**À PIED** 40,5 CL  
 STEMMED 13 OZ<sup>11/16</sup>  
 GLASS Ø 8,3 CM  
 H 24,5 CM  
 Ø 3 IN<sup>17/64</sup>  
 H 9 IN<sup>41/64</sup>



**VERRE 242791**  
**À PIED** 57 CL  
 STEMMED 19 OZ<sup>9/32</sup>  
 GLASS Ø 9,6 CM  
 H 25 CM  
 Ø 3 IN<sup>25/32</sup>  
 H 9 IN<sup>27/32</sup>



**VERRE 242790**  
**À BORDEAUX** 64,5 CL  
 BORDEAUX 21 OZ<sup>13/16</sup>  
 GLASS Ø 10,2 CM  
 H 25,5 CM  
 Ø 4 IN<sup>1/64</sup>  
 H 10 IN<sup>3/64</sup>



**VERRE 242789**  
**À BOURGOGNE** 71 CL  
 BURGUNDY 24 OZ<sup>1/64</sup>  
 GLASS Ø 11,6 CM  
 H 24,5 CM  
 Ø 4 IN<sup>9/16</sup>  
 H 9 IN<sup>41/64</sup>



**GOBELET 242795**  
**HAUT** 47 CL - 15 OZ<sup>57/64</sup>  
 HIGH Ø 9,15 X H 10,85 CM  
 TUMBLER Ø 3 IN<sup>39/64</sup> X H 4 IN<sup>17/64</sup>



**GOBELET 242794**  
**BAS** 39 CL - 13 OZ<sup>3/16</sup>  
 LOW Ø 7 X H 14,4 CM  
 TUMBLER Ø 2 IN<sup>3/4</sup> X H 5 IN<sup>43/64</sup>

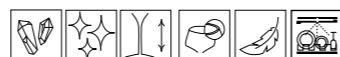



ANYTIME

All day dining

MADE IN EUROPE



**FLÛTE 184567**  
**À CHAMPAGNE** 15 CL  
CHAMPAGNE 5 OZ<sup>1/16</sup>  
FLUTE Ø 6,3 CM  
H 19,3 CM  
Ø 2 IN<sup>1/2</sup>  
H 7 IN<sup>5/8</sup>



**VERRE 184597**  
**À CHAMPAGNE** 21 CL  
CHAMPAGNE 7 OZ<sup>1/8</sup>  
GLASS Ø 6,8 CM  
H 20,5 CM  
Ø 2 IN<sup>11/16</sup>  
H 8 IN<sup>1/16</sup>



**COUPE 210281**  
**À CHAMPAGNE** 23 CL  
CHAMPAGNE 7 OZ<sup>3/4</sup>  
GLASS Ø 9,5 CM  
H 14,7 CM  
Ø 3 IN<sup>3/4</sup>  
H 5 IN<sup>13/16</sup>



**VERRE 195628**  
**À MARTINI** 25 CL  
MARTINI GLASS 8 OZ<sup>7/16</sup>  
Ø 10,6 CM  
H 16,8 CM  
Ø 4 IN<sup>3/16</sup>  
H 6 IN<sup>5/8</sup>



**VERRE 184570**  
**À COGNAC** 61 CL  
COGNAC 20 OZ<sup>5/8</sup>  
GLASS Ø 10,4 CM  
H 15,5 CM  
Ø 4 IN<sup>1/8</sup>  
H 6 IN<sup>1/8</sup>

ORIGINE

POUR LES VINS MOELLEUX ET LIQUEUREUX  
FOR SWEET & SYRUPY WINES  
PARA LOS VINOS MELOSOS  
Y LICOROSOS



**VERRE N°5 216734\***  
GLASS 20 CL  
6 OZ<sup>3/4</sup>  
Ø 6,9 CM  
H 20 CM  
Ø 2 IN<sup>11/16</sup>  
H 7 IN<sup>7/8</sup>

\*Arrêt à épuisement des stocks  
Until stock limited



L'abus d'alcool est dangereux pour la santé  
Alcohol abuse is dangerous for your health

DOMAINE

All day dining

MADE IN EUROPE



**FLÛTE 184566**  
CHAMPAGNE 19 CL  
CHAMPAGNE 6 OZ<sup>7/16</sup>  
FLUTE Ø 5,3 CM  
H 21,9 CM  
Ø 2 IN<sup>1/16</sup>  
H 8 IN<sup>5/8</sup>

**VERRE 184563**  
À VIN BLANC 28 CL  
WHITE WINE 9 OZ<sup>7/16</sup>  
GLASS Ø 7,3 CM  
H 21,2 CM  
Ø 2 IN<sup>7/8</sup>  
H 8 IN<sup>3/8</sup>

**VERRE 184562**  
À VIN ROUGE 37 CL  
RED WINE 12 OZ<sup>1/2</sup>  
GLASS Ø 7,7 CM  
H 21,4 CM  
Ø 3 IN<sup>1/16</sup>  
H 8 IN<sup>7/16</sup>

**VERRE 184561**  
À EAU 49,5 CL  
WATER 16 OZ<sup>3/4</sup>  
GLASS Ø 8,6 CM  
H 22,7 CM  
Ø 3 IN<sup>3/8</sup>  
H 8 IN<sup>15/16</sup>

**VERRE 184564**  
À BORDEAUX 65 CL  
BORDEAUX 22 OZ  
GLASS Ø 9,4 CM  
H 23,9 CM  
Ø 3 IN<sup>11/16</sup>  
H 9 IN<sup>7/16</sup>

**VERRE 184565**  
À BOURGOGNE 75 CL  
BURGUNDY 25 OZ<sup>3/8</sup>  
GLASS Ø 10,7 CM  
H 22,5 CM  
Ø 4 IN<sup>3/16</sup>  
H 8 IN<sup>7/8</sup>





**FLÛTE 184556**  
**À CHAMPAGNE** 20 CL - 6 OZ<sup>3/4</sup>  
 CHAMPAGNE Ø 6,7 X H 21,2 CM  
 FLÛTE Ø 2 IN<sup>5/8</sup> X H 8 IN<sup>3/8</sup>



**VERRE 190537**  
**À VIN** 35 CL - 11 OZ<sup>3/16</sup>  
 WINE GLASS Ø 7,8 X H 19,6 CM  
 Ø 3 IN<sup>7/16</sup> X H 7 IN<sup>11/16</sup>



**VERRE 190536**  
**À EAU** 45 CL - 15 OZ<sup>2/16</sup>  
 WATER GLASS Ø 8,4 X H 20,5 CM  
 Ø 3 IN<sup>5/16</sup> X H 8 IN<sup>1/16</sup>



**Décor taillé dans le verre**  
 Cut-glass design



**GOBELET 190538**  
 TUMBLER 47 CL - 15 OZ<sup>7/8</sup>  
 Ø 8,5 X H 12,1 CM  
 Ø 3 IN<sup>3/8</sup> X H 4 IN<sup>3/4</sup>



# MONTMARTRE

All day dining

MADE IN EUROPE



**FLÛTE 184580**  
**À CHAMPAGNE** 21 CL  
 CHAMPAGNE 7 OZ<sup>1/8</sup>  
 FLÛTE Ø 7 CM  
 H 21 CM  
 Ø 2 IN<sup>3/4</sup>  
 H 8 IN<sup>1/4</sup>



**VERRE 184577**  
**À VIN BLANC** 25 CL  
 WHITE WINE 8 OZ<sup>7/16</sup>  
 GLASS Ø 7,5  
 H 18,4 CM  
 Ø 2 IN<sup>15/16</sup>  
 H 7 IN<sup>1/4</sup>



**VERRE 184576**  
**À VIN ROUGE** 32 CL  
 RED WINE 10 OZ<sup>13/16</sup>  
 GLASS Ø 7,8 CM  
 H 19,8 CM  
 Ø 3 IN<sup>1/16</sup>  
 H 7 IN<sup>13/16</sup>



**VERRE 184575**  
**À EAU** 42 CL  
 WATER GLASS 14 OZ<sup>3/16</sup>  
 Ø 8,7 CM  
 H 20,5 CM  
 Ø 3 IN<sup>7/16</sup>  
 H 8 IN<sup>1/16</sup>



**VERRE 184579**  
**À BOURGOGNE** 58 CL  
 BURGUNDY GLASS 19 OZ<sup>5/8</sup>  
 Ø 10 CM  
 H 20 CM  
 Ø 3 IN<sup>15/16</sup>  
 H 7 IN<sup>7/8</sup>

MONTMARTRE  
 JAUGÉ



**VERRE 208481**  
**À VIN ROUGE** 32 CL - 10 OZ<sup>13/16</sup>  
**AVEC** Ø 7,8 X H 19,8 CM  
**DOUBLE JAUGE** Ø 3 IN<sup>1/16</sup> X H 7 IN<sup>13/16</sup>  
 RED WINE GLASS  
 WITH 2 GAUGES

HYPNOTIC  
 JAUGÉ



**213816**  
 36,5 CL - 13 OZ  
 Ø 8,2 X H 22 CM  
 Ø 3 IN<sup>1/4</sup> X H 8 IN<sup>11/16</sup>

**Avec double jauge**  
 With 2 gauges

• ..... 14 CL - 4 OZ<sup>3/4</sup>  
 • ..... 12,5 CL - 4 OZ<sup>1/4</sup>



L'abus d'alcool est dangereux pour la santé  
 Alcohol abuse is dangerous for your health

MUSE

Finedining

MADE IN EUROPE



<b>FLÛTE 184551</b> CHAMPAGNE 19 CL CHAMPAGNE 6 OZ <sup>7/16</sup> FLUTE Ø 6,3 CM H 22,4 CM Ø 2 IN <sup>1/2</sup> H 8 IN <sup>3/16</sup>	<b>VERRE 184549</b> À VIN BLANC 28 CL WHITE WINE 9 OZ <sup>7/16</sup> GLASS Ø 7,4 CM H 20,8 CM Ø 2 IN <sup>5/16</sup> H 8 IN <sup>3/16</sup>	<b>VERRE 184548</b> À VIN ROUGE 35 CL RED WINE 11 OZ <sup>13/16</sup> GLASS Ø 8 CM H 21,4 CM Ø 3 IN <sup>1/8</sup> H 8 IN <sup>7/16</sup>	<b>VERRE 184547</b> À EAU 45 CL WATER 15 OZ <sup>3/16</sup> GLASS Ø 8,4 CM H 22,5 CM Ø 3 IN <sup>5/16</sup> H 8 IN <sup>1/16</sup>	<b>VERRE 184550</b> À BORDEAUX 64,5 CL BORDEAUX 21 OZ <sup>13/16</sup> GLASS Ø 9,5 CM H 23,8 CM Ø 3 IN <sup>3/4</sup> H 9 IN <sup>3/8</sup>	<b>VERRE 210812</b> À BOURGOGNE 70 CL BURGUNDY 23 OZ <sup>1/16</sup> GLASS Ø 10,5 CM H 23,1 CM Ø 4 IN <sup>1/8</sup> H 9 IN <sup>1/8</sup>
--	--	---	--	---	--



**GOBELET 184555**  
HAUT 36 CL - 12 OZ<sup>3/16</sup>  
HIGH Ø 6,8 X H 14,2 CM  
TUMBLER Ø 2 IN<sup>11/16</sup> X H 5 IN<sup>9/16</sup>



**GOBELET 184554**  
BAS 33 CL - 11 OZ<sup>3/16</sup>  
LOW Ø 8 X H 10,2 CM  
TUMBLER Ø 3 IN<sup>1/8</sup> X H 4 IN

**184553**  
23 CL - 7 OZ<sup>3/4</sup>  
Ø 7,6 X H 9,2 CM  
Ø 3 IN X H 3 IN<sup>5/8</sup>



L'abus d'alcool est dangereux pour la santé  
Alcohol abuse is dangerous for your health

# NEWPORT TWIST

Finedining

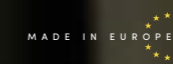

NEW



**FLÛTE 244051**  
**CHAMPAGNE** 21 CL  
 CHAMPAGNE 8 OZ<sup>1/4</sup>  
 FLUTE Ø 6,3 CM  
 H 22,4 CM  
 Ø 2 IN<sup>1/2</sup>  
 H 8 IN<sup>13/16</sup>



**VERRE 244059**  
**À PIED** 36 CL  
 STEMMED 12 OZ<sup>3/16</sup>  
 GLASS Ø 8 CM  
 H 22,5 CM  
 Ø 3 IN<sup>1/8</sup>  
 H 8 IN<sup>7/8</sup>



**VERRE 244057**  
**À PIED** 47 CL  
 STEMMED 15 OZ<sup>7/8</sup>  
 GLASS Ø 9,3 CM  
 H 24 CM  
 Ø 3 IN<sup>11/16</sup>  
 H 9 IN<sup>7/16</sup>



**COUPE À GLACE/**  
**COCKTAIL** 28 CL  
 COCKTAIL/ICE 11 OZ  
 CUP GLASS Ø 8 CM  
 H 21,4 CM  
 Ø 3 IN<sup>1/8</sup>  
 H 8 IN<sup>7/16</sup>



**VERRE 244049**  
**À MARTINI** 21 CL  
 MARTINI 8 OZ<sup>1/4</sup>  
 GLASS Ø 7,4 CM  
 H 20,8 CM  
 Ø 2 IN<sup>15/16</sup>  
 H 8 IN<sup>1/16</sup>



**VERRE 244055**  
**À LIQUEUR** 7,5 CL  
 BURGUNDY 2 OZ<sup>15/16</sup>  
 GLASS Ø 6,3 CM  
 H 22,4 CM  
 Ø 2 IN<sup>1/2</sup>  
 H 8 IN<sup>15/16</sup>



**VERRINE 244047**  
**APÉRITIF** 27 CL - 10 OZ<sup>5/8</sup>  
 VERRINE Ø 7,4 X H 20,8 CM  
 APPETIZER Ø 2 IN<sup>5/16</sup> X H 8 IN<sup>1/16</sup>



**GOBELET 244061**  
**HAUT** 37 CL - 12 OZ<sup>1/2</sup>  
 HIGH Ø 6,5 X H 16 CM  
 DRINK Ø 2 IN<sup>9/16</sup> X H 6 IN<sup>5/16</sup>



**CARAFE 244910** **NEW**  
 CARAFE 100 CL - 33 OZ<sup>13/16</sup>  
 Ø 8,8 X H 28,3 CM  
 Ø 3 IN<sup>7/16</sup> X H 11 IN<sup>1/8</sup>

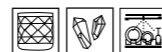

L'abus d'alcool est dangereux pour la santé  
 Alcohol abuse is dangerous for your health



**COFFRET SET WHISKY 241875**  
**2 VERRES + CARAFE** 21 CL - 7 OZ<sup>1/8</sup>  
**EMPILABLES** 31,9 CM  
2 GLASSES & CARAFE 12 IN<sup>9/16</sup>  
STACKABLE SET



**CARAFE 242961**  
CARAFE 25 CL - 8 OZ<sup>7/16</sup>  
18 CM  
7 IN<sup>1/16</sup>



**GOBELET 242959**  
**BAS** 25 CL - 8 OZ<sup>7/16</sup>  
SHORT Ø 7,4  
DRINK Ø 2 IN<sup>15/16</sup>



# NEWPORT TWIST

Finedining

MADE IN EUROPE



L'abus d'alcool est dangereux pour la santé  
Alcohol abuse is dangerous for your health



E S  
G O B E L E T S  
T U M B L E R S



# ALLEGRO

All day dining

ROUGE  
RED



**GOBELET** **225516**  
TUMBLER 29 CL - 9 OZ<sup>13/16</sup>  
Ø 7,2 X H 9,5 CM  
Ø 2 IN<sup>13/16</sup> X H 3 IN<sup>3/4</sup>

NOIR  
BLACK



**180936**  
29 CL - 9 OZ<sup>13/16</sup>  
Ø 7,2 X H 9,5 CM  
Ø 2 IN<sup>13/16</sup> X H 3 IN<sup>3/4</sup>

CASSIS  
PURPLE



**174510**  
29 CL - 9 OZ<sup>13/16</sup>  
Ø 7,2 X H 9,5 CM  
Ø 2 IN<sup>13/16</sup> X H 3 IN<sup>3/4</sup>

TRANSPARENT  
TRANSPARENT



**206936**  
29 CL - 9 OZ<sup>13/16</sup>  
Ø 7,2 X H 9,5 CM  
Ø 2 IN<sup>13/16</sup> X H 3 IN<sup>3/4</sup>

GRIS  
GREY



**225517**  
29 CL - 9 OZ<sup>13/16</sup>  
Ø 7,2 X H 9,5 CM  
Ø 2 IN<sup>13/16</sup> X H 3 IN<sup>3/4</sup>

BLEU NUIT  
BLUE NIGHT



**199461**  
29 CL - 9 OZ<sup>13/16</sup>  
Ø 7,2 X H 9,5 CM  
Ø 2 IN<sup>13/16</sup> X H 3 IN<sup>3/4</sup>

BLANC  
WHITE



**180939**  
29 CL - 9 OZ<sup>13/16</sup>  
Ø 7,2 X H 9,5 CM  
Ø 2 IN<sup>13/16</sup> X H 3 IN<sup>3/4</sup>

VERRE SOUFLÉ BOUCHE TEINTÉ DANS LA MASSE  
HAND-BLOWN INTEGRALLY DYED GLASS



L'abus d'alcool est dangereux pour la santé  
Alcohol abuse is dangerous for your health



# COSMOPOLITAIN

Alldaydining

MADE IN EUROPE



**GOBELET 184589**  
**HAUT** 35 CL - 11 OZ<sup>13/16</sup>  
 HIGH Ø 6,5 X H 14,4 CM  
 TUMBLER Ø 2 IN<sup>9/16</sup> X H 5 IN<sup>11/16</sup>



**GOBELET 184588**  
**HAUT** 29 CL - 9 OZ<sup>13/16</sup>  
 HIGH Ø 7 X H 10,7 CM  
 TUMBLER Ø 2 IN<sup>3/4</sup> X H 4 IN<sup>3/16</sup>



**GOBELET 189774**  
**BAS** 42 CL - 14 OZ<sup>3/16</sup>  
 LOW Ø 8,5 X H 10,6 CM  
 TUMBLER Ø 3 IN<sup>3/8</sup> X H 4 IN<sup>3/16</sup>



**GOBELET 184586**  
**BAS** 32 CL - 10 OZ<sup>13/16</sup>  
 LOW Ø 8 X H 9,4 CM  
 TUMBLER Ø 3 IN<sup>1/8</sup> X H 3 IN<sup>11/16</sup>

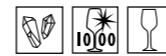

**GOBELET 169851**  
**HAUT** 57 CL - 19 OZ<sup>1/4</sup>  
 HIGH Ø 6,7 X H 11,5 CM  
 TUMBLER Ø 2 IN<sup>5/8</sup> X H 4 IN<sup>1/2</sup>



**GOBELET 169852**  
**BAS** 43 CL - 14 OZ<sup>29/16</sup>  
 LOW Ø 6,1 X H 10 CM  
 TUMBLER Ø 2 IN<sup>3/8</sup> X H 3 IN<sup>15/16</sup>



# DOLCE

Finedining



L'abus d'alcool est dangereux pour la santé  
 Alcohol abuse is dangerous for your health

TRANSPARENT  
TRANSPARENT



**VERRE 234149**  
**À PIED** 26 CL - 8 OZ<sup>3/4</sup>  
STEMMED Ø 7,9 X H 11,1 CM  
GLASS Ø 3 IN<sup>1/8</sup> X H 4 IN<sup>3/8</sup>

BLEU  
BLUE



**236287**  
26 CL - 8 OZ<sup>3/4</sup>  
Ø 7,9 X H 11,1 CM  
Ø 3 IN<sup>1/8</sup> X H 4 IN<sup>3/8</sup>

VERT  
GREEN



**242553**  
26 CL - 8 OZ<sup>3/4</sup>  
Ø 7,9 X H 11,1 CM  
Ø 3 IN<sup>1/8</sup> X H 4 IN<sup>3/8</sup>

GRIS  
GREY



**242555**  
26 CL - 8 OZ<sup>3/4</sup>  
Ø 7,9 X H 11,1 CM  
Ø 3 IN<sup>1/8</sup> X H 4 IN<sup>3/8</sup>



**GOBELET 234150**  
TUMBLER 26 CL - 8 OZ<sup>3/4</sup>  
Ø 7,1 X H 9,1 CM  
Ø 2 IN<sup>13/16</sup> X H 3 IN<sup>9/16</sup>



**236289**  
26 CL - 8 OZ<sup>3/4</sup>  
Ø 7,1 X H 9,1 CM  
Ø 2 IN<sup>13/16</sup> X H 3 IN<sup>9/16</sup>



**242552**  
26 CL - 8 OZ<sup>3/4</sup>  
Ø 7,1 X H 9,1 CM  
Ø 2 IN<sup>13/16</sup> X H 3 IN<sup>9/16</sup>



**242554**  
26 CL - 8 OZ<sup>3/4</sup>  
Ø 7,1 X H 9,1 CM  
Ø 2 IN<sup>13/16</sup> X H 3 IN<sup>9/16</sup>



**CARAFE 234148**  
**EMPILEO** 75 CL - 25 OZ<sup>3/8</sup>  
PITCHER Ø 9,1 X H 24 CM  
Ø 3 IN<sup>9/16</sup> X H 4 IN<sup>3/8</sup>



**236288**  
75 CL - 25 OZ<sup>3/8</sup>  
Ø 9,1 X H 24 CM  
Ø 3 IN<sup>9/16</sup> X H 4 IN<sup>3/8</sup>



• **VERRE SOUFFLÉ BOUCHE**  
**TEINTÉ DANS LA MASSE**  
HAND-BLOWN INTEGRALLY  
DYED GLASS



• **EMPILABILITÉ**  
STACKABLE



# EMPILEO

All day dining



L'abus d'alcool est dangereux pour la santé  
Alcohol abuse is dangerous for your health



**243495\***  
32 CL - 10 OZ<sup>13/16</sup>  
Ø 6 X H 13,7 CM  
Ø 2 IN<sup>3/8</sup> X H 5 IN<sup>3/8</sup>



**243497\***  
40 CL - 13 OZ<sup>1/2</sup>  
Ø 6 X H 16,5 CM  
Ø 2 IN<sup>3/8</sup> X H 6 IN<sup>1/2</sup>

\*Arrêt à épuisement des stocks  
Until stock limited



# INSTANT

Alldaydining

MADE IN EUROPE



**GOBELET 184601**  
**HAUT** 39 CL - 13 OZ<sup>3/16</sup>  
HIGH Ø 6,6 X H 14,5 CM  
TUMBLER Ø 2 IN<sup>5/8</sup> X H 5 IN<sup>11/16</sup>



**GOBELET 184600**  
**BAS** 35 CL - 11 OZ<sup>13/16</sup>  
LOW Ø 7,9 X H 9,1 CM  
TUMBLER Ø 3 IN<sup>1/8</sup> X H 3 IN<sup>9/16</sup>



**GOBELET BAS/ VERRINE** 184598  
19 CL - 6 OZ<sup>2/16</sup>  
LOW TUMBLER/ APPETIZER GLASS  
Ø 6,7 X H 8,1 CM  
Ø 2 IN<sup>5/8</sup> X H 3 IN<sup>3/16</sup>



# LOOP

Alldaydining

MADE IN EUROPE

L'abus d'alcool est dangereux pour la santé  
Alcohol abuse is dangerous for your health

GRIS  
GREY



**GOBELET 171631**  
TUMBLER 34 CL - 11 OZ<sup>1/2</sup>  
Ø 8,5 X H 10 CM  
Ø 3 IN<sup>3/8</sup> X H 3 IN<sup>15/16</sup>

VERT  
GREEN



**171632**  
34 CL - 11 OZ<sup>1/2</sup>  
Ø 8,5 X H 10 CM  
Ø 3 IN<sup>3/8</sup> X H 3 IN<sup>15/16</sup>

VIOLET  
PURPLE



**171633**  
34 CL - 11 OZ<sup>1/2</sup>  
Ø 8,5 X H 10 CM  
Ø 3 IN<sup>3/8</sup> X H 3 IN<sup>15/16</sup>

ROUGE  
RED



**171630**  
34 CL - 11 OZ<sup>1/2</sup>  
Ø 8,5 X H 10 CM  
Ø 3 IN<sup>3/8</sup> X H 3 IN<sup>15/16</sup>

EMPILABILITE  
STACKABLE



VERRE SOUFFLÉ BOUCHE TEINTÉ DANS LA MASSE  
HAND-BLOWN INTEGRALLY DYED GLASS



MAMBO

Alldaydining



**VERRE 236340**  
À PIED 27 CL - 9 OZ<sup>1/8</sup>  
STEMMED Ø 7,2 X H 11,5 CM  
GLASS Ø 2 IN<sup>13/16</sup> X H 4 IN<sup>1/2</sup>



**GOBELET 236338**  
BAS 18 CL - 7 OZ<sup>1/16</sup>  
LOW Ø 7,2 X H 6,5 CM  
TUMBLER Ø 2 IN<sup>13/16</sup> X H 2 IN<sup>9/16</sup>



**GOBELET 236339**  
HAUT 45 CL - 15 OZ<sup>3/16</sup>  
HIGH Ø 7,2 X H 14 CM  
TUMBLER Ø 2 IN<sup>13/16</sup> X H 5 IN<sup>1/2</sup>



VERRES SOUFFLÉS BOUCHE  
HAND-BLOWN GLASSES



ROC

Alldaydining

TRANSPARENT  
TRANSPARENT

BLEU  
BLUE



**CARAFE 234148**  
**EMPILEO** 75 CL - 25 OZ<sup>3/8</sup>  
PITCHER Ø 9,1 X H 24 CM  
Ø 3 IN<sup>9/16</sup> X H 4 IN<sup>3/8</sup>

**236288**  
75 CL - 25 OZ<sup>3/8</sup>  
Ø 9,1 X H 24 CM  
Ø 3 IN<sup>9/16</sup> X H 4 IN<sup>3/8</sup>

**CARAFE À JUS 202639**  
**DE FRUITS** 1,2 L - 40 OZ<sup>3/16</sup>  
**EVENTO** Ø 10,5 X H 27,5 CM  
JUICE/ Ø 4 IN<sup>1/8</sup> X H 10 IN<sup>13/16</sup>  
BEVERAGE  
CARAFE

**BOUCHON DE 202855**  
**CARAFE** Ø 6,5 CM - 2 IN<sup>9/16</sup>  
**SILICONE**  
**EVENTO**  
SILICONE  
STOPPER  
FOR CARAFE



**COFFRET SET WHISKY 241875**  
**2 VERRES + CARAFE** 21 CL - 7 OZ<sup>1/8</sup>  
**EMPILABLES** 31,9 CM  
2 GLASSES & CARAFE 12 IN<sup>9/16</sup>  
STACKABLE SET

**CARAFE 244910 NEW**  
CARAFE 100 CL - 33 OZ<sup>13/16</sup>  
Ø 8,8 X H 28,3 CM  
Ø 3 IN<sup>7/16</sup> X H 11 IN<sup>1/8</sup>

**DECANTEUR 169728**  
**MILLÉSIME** 1,35 L - 45 OZ<sup>5/8</sup>  
DECANTER Ø 20,5 X H 23,5 CM  
Ø 8 IN<sup>1/8</sup> X H 9 IN<sup>1/4</sup>

**DECANTEUR 210904**  
**NECTAR** 1 L - 33 OZ<sup>13/16</sup>  
DECANTER Ø 13,5 X H 24,5 CM  
Ø 5 IN<sup>5/16</sup> X H 9 IN<sup>5/8</sup>





# L E B U F F E T E V E N T O B U F F E T

Du petit-déjeuner au dîner, des buffets sucrés aux buffets salés, la collection EVENTO répond à tous les scénarios de réception tout en assurant une hygiène parfaite pour satisfaire au mieux les nouvelles exigences de vos clients.

From breakfast to dinner, from sweet buffets to savoury spreads, the EVENTO collection works for all your reception needs while ensuring perfect hygiene to best meet the new requirements of your customers.



# EVENTO

## Buffet



Le buffet EVENTO au design homogène, harmonieux, fonctionnel et modulable, dispose de nombreux produits qui éviteront d'exposer leur contenu à l'air libre tout en conservant les aliments au frais comme au chaud et qui peuvent être utilisés pour la majorité en portion individuelle ou à usage unique. La richesse de ses combinaisons et la diversité de ses matériaux (acier, porcelaine, verre, grès, mélamine pierre et bois etc...) s'adaptent à votre style et à la dimension de votre établissement. La collection EVENTO valorise avec une touche de chic la mise en scène de vos buffets, selon le moment de la journée, de la saison...

The EVENTO buffet with a unified, harmonious, practical and modular design has many products that will avoid exposing their contents to the open air while keeping the food cool as well as warm and which can be used for the most part in individual portions or single use. With a host of combinations and a range of materials to choose from (steel, porcelain, glass, stoneware, melamine, stone and wood...), you can find what works for your style and the size of your space. The EVENTO collection adds a chic touch to your buffet presentations to reflect the time of day or the season.



## CHAFING DISHES\*

Couvercle en verre transparent pour percevoir le contenu et rendre le buffet plus gourmand

Clear glass cover allows contents to be viewed instantly and makes the buffet more enticing

Charnière avec vérin et amortisseur pour un réel confort d'utilisation et une fermeture en douceur

The hydraulic buffering hinge offers user comfort and convenience with its soft closure mechanism

Encoches pour les couverts de service  
The notch for the serving cutlery

Compatible plaque induction, avec résistance électrique ou porte-brûleur avec gel combustible

Compatible with induction, electrical and/or «sterno» fuel heating system

Acier inoxydable, couvercle avec gouttière, verre trempé, système de récupération d'eau de condensation

Stainless steel, lid with groove, condensation water collection system in the porcelain insert



2 FINITIONS  
FINISHES

MIROIR  
MIRROR

BROSSÉ  
BRUSHED

## CHAFING DISHES



Le Chafing dish, par son design contemporain alliant acier, porcelaine et verre offre à votre buffet une présentation soignée et raffinée.  
The Chafing dish, with its contemporary design that combines steel, porcelain and glass, brings a smart and sophisticated touch to your buffet display.

\*Certaines pièces sont disponibles en pièces détachées  
Some items are available individually

**CHAFING DISHES\***

**FINITION MIROIR**  
MIRROR FINISH



**FINITION BROSSÉE**  
BRUSHED FINISH



**ACIER**  
STAINLESS STEEL

**PORCELAINE**  
PORCELAIN

**CHAFING DISH 236195**  
SANS BAC Ø 35,5 CM - P 41 CM - H 15 CM  
ACIER INOXYDABLE Ø 14 IN - D 16 IN<sup>1/8</sup> - H 5 IN<sup>7/8</sup>  
+ COUVERCLE  
AVEC GOUTIÈRE  
VERRE TREMPÉ  
CHAFING DISH  
WITHOUT INSERT  
STAINLESS STEEL  
+ LID WITH GROOVE,  
TEMPERED GLASS

**236194**  
Ø 35,5 CM - P 41 CM - H 15 CM  
Ø 14 IN - D 16 IN<sup>1/8</sup> - H 5 IN<sup>7/8</sup>

**COUVERCLE 203470**  
AVEC GOUTIÈRE ACIER, Ø 33 CM - 13 IN  
VERRE TREMPÉ  
LID WITH STAINLESS STEEL  
GUTTER,  
TEMPERED GLASS

**BAC POUR 216142**  
CHAFING DISH  
CHAFING INSERT  
Ø 35,6 X H 7 CM  
CONTENANCE 3L  
Ø 14 X 2 IN<sup>3/4</sup>  
CAPACITY 100 OZ

**215721**  
Ø 35,6 X H 7 CM  
CONTENANCE 3L  
Ø 14 X 2 IN<sup>3/4</sup>  
CAPACITY 100 OZ

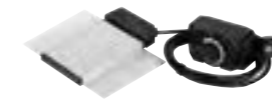

**RÉSISTANCE 202860**  
AVEC RÉGULATEUR 220 /240 V /200 W  
DE TEMPÉRATURE 20 X 20 CM - 7 IN<sup>7/8</sup> X 7 IN<sup>7/8</sup>  
HEATING ELEMENT  
HEAT ADJUSTABLE **246341 NEW**  
500 W  
20 X 20 CM - 7 IN<sup>7/8</sup> X 7 IN<sup>7/8</sup>

**1/2 BAC PORCELAINE 202635**  
POUR  
CHAFING DISH  
L 29 X L 15 X H 4,5 CM  
CONTENANCE 1L  
1/2 CHAFING 11 IN<sup>7/16</sup> X 5 IN<sup>7/8</sup> X 1 IN<sup>3/4</sup>  
PORCELAIN INSERT CAPACITY 33 OZ<sup>13/16</sup>



**SUPPORT CHAFING 203005**  
ACIER INOXYDABLE Ø 35 CM - P 40 CM - H 12,5 CM  
POUR RÉSISTANCE ÉLECTRIQUE Ø 13 IN<sup>3/4</sup> - D 15 IN<sup>3/4</sup> - H 4 IN<sup>15/16</sup>  
OU PORTE-BRÛLEUR  
AVEC GEL COMBUSTIBLE  
CHAFING STAND STAINLESS STEEL,  
FOR ELECTRICAL AND/OR  
STERNO HEATING PURPOSES

**202859**  
Ø 35 CM - P 40 CM - H 12,5 CM  
Ø 13 IN<sup>3/4</sup> - D 15 IN<sup>3/4</sup> - H 4 IN<sup>15/16</sup>

**PORTE-BRÛLEUR 243950**  
POUR GEL Ø 9 CM - H 6 CM  
COMBUSTIBLE ACIER Ø 3 IN<sup>9/16</sup> X 2 IN<sup>3/8</sup>  
BURNER HOLDER STEEL

\*Certaines pièces sont disponibles en pièces détachées  
Some items are available individually

\*À commander obligatoirement avec le bac pour chafing dish (216142 ou 215721)  
Must be ordered with the chafing insert (216142 or 215721)

# REFRIGERATED UNITS\*



L 56,5 CM X P 36 CM X H 9,5 CM  
22 IN<sup>1/4</sup> X D 14 IN<sup>13/16</sup> X 3 IN<sup>3/4</sup>

**FINITION MIROIR**  
MIRROR FINISH



**MODULE ACIER 202864**  
+ BAC PLASTIQUE<sup>(1)</sup> GN1/1  
REFRIGERATED SET L 56,5 CM - P 36 CM - H 9,5 CM  
+ PLASTIC TRAY 22 IN<sup>1/4</sup> - D 14 IN<sup>13/16</sup> X 3 IN<sup>3/4</sup>

**235356**  
GN1/2  
29,5 X 35,6 CM  
11 IN<sup>5/8</sup> X 14 IN



**COUVERCLE 202871**  
MODULE RÉFRIGÉRÉ 56 X 35 X 19 CM  
POIGNÉE INOXYDABLE 22 IN<sup>1/16</sup> X 13 IN<sup>3/4</sup> X 7 IN<sup>1/2</sup>  
LID FOR REFRIGERATED SET/  
STAINLESS STEEL HANDLE

**FINITION BROSSÉE**  
BRUSHED FINISH



**202865**  
GN1/1  
L 56,5 CM - P 36 CM - H 9,5 CM  
22 IN<sup>1/4</sup> - D 14 IN<sup>13/16</sup> X 3 IN<sup>3/4</sup>

**235361**  
GN1/2  
29,5 X 35,6 CM  
11 IN<sup>5/8</sup> X 14 IN

**FINITION NOIR MÉTALLISÉ**  
METALLIC BLACK FINISH



**202869**  
GN1/1  
L 56,5 CM - P 36 CM - H 9,5 CM  
22 IN<sup>1/4</sup> - D 14 IN<sup>13/16</sup> X 3 IN<sup>3/4</sup>

**235362**  
GN1/2  
29,5 X 35,6 CM  
11 IN<sup>5/8</sup> X 14 IN

**PLAQUE EUTECTIQUE 208357**  
NOIRE POUR GN1/1  
MODULE FROID 48 X 28 X 3 CM  
BLACK COOLING 18 IN<sup>7/8</sup> X 11 IN X 1 IN<sup>3/16</sup>  
EUTECTIQUE BLOCK FOR UNIT

**239786**  
GN1/2  
18 X 25 CM  
7 IN<sup>18/16</sup> X 9 IN<sup>13/16</sup>

3 FINITIONS  
FINISHES

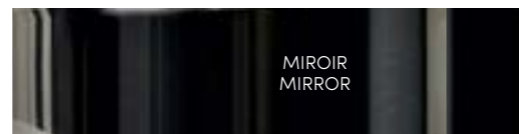

MIROIR  
MIRROR

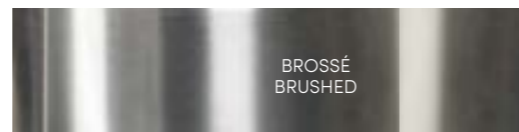

BROSSÉ  
BRUSHED



NOIR MÉTALLISÉ  
METALLIC BLACK

\*Certaines pièces sont disponibles en pièces détachées  
Some items are available individually

(1) Garantie lave-vaisselle  
Dish washer safe

# MODULES FROIDS



Le module réfrigéré reçoit une large gamme de contenants, plateaux et accessoires multi-matériaux au format GN en porcelaine, verre, acier, acrylique, mélamine pierre et mélamine bois. Ils permettent une infinité de combinaisons.  
The refrigerated unit will hold a wide range of platters and multi-material accessories in industry standard format in porcelain, glass, steel, acrylic stone and wood melamine allowing endless combinations.

PLATEAUX POUR MODULES FROIDS PLATTERS FOR REFRIGERATED UNITS

MÉLAMINE BOIS<sup>(1)</sup>  
WOOD MELAMINE TRAY



PLATEAUX **234546**  
TRAYS **GN1/1**

53,5 X 32,5 CM  
20 IN<sup>7/8</sup> X 12 IN<sup>13/16</sup>

**234548**  
**GN 2/3**  
35,4 X 32,5 CM  
13 IN<sup>15/16</sup> X 12 IN<sup>13/16</sup>

**234551**  
**GN 1/2**  
26,4 X 32,5 CM  
10 IN<sup>3/8</sup> X 12 IN<sup>13/16</sup>

**234553**  
**GN 1/3**  
17,5 X 32,5 CM  
6 IN<sup>7/8</sup> X 12 IN<sup>13/16</sup>



PLATEAUX **234557**  
**3 TROUS**  
3 HOLES TRAYS **GN 1/6**  
8,7 X 32,5 CM  
3 IN<sup>7/16</sup> X 12 IN<sup>13/16</sup>

MÉLAMINE PIERRE<sup>(1)</sup>  
STONE MELAMINE TRAY



**234547**  
**GN1/1**  
53,5 X 32,5 CM  
20 IN<sup>7/8</sup> X 12 IN<sup>13/16</sup>

**234549**  
**GN 2/3**  
35,4 X 32,5 CM  
13 IN<sup>15/16</sup> X 12 IN<sup>13/16</sup>

**234552**  
**GN 1/2**  
26,4 X 32,5 CM  
10 IN<sup>3/8</sup> X 12 IN<sup>13/16</sup>

**234554**  
**GN 1/3**  
17,5 X 32,5 CM  
6 IN<sup>7/8</sup> X 12 IN<sup>13/16</sup>



**234558**  
**GN 1/6**  
8,7 X 32,5 CM  
3 IN<sup>7/16</sup> X 12 IN<sup>13/16</sup>

ACIER 18/10 NEWPORT  
FINITION MIROIR  
SERVING TRAY STAINLESS STEEL  
18/10 MIRROR FINISHED



**238962**  
**GN1/1**  
53,5 X 32,5 CM  
20 IN<sup>7/8</sup> X 12 IN<sup>13/16</sup>

**238960**  
**GN 1/2**  
26,4 X 32,5 CM  
10 IN<sup>3/8</sup> X 12 IN<sup>13/16</sup>

VERRE ÉPAISSEUR 0,6 CM  
TEMPERED GLASS THICKNESS IN<sup>1/4</sup>



**230752**  
**GN 1/1**  
53,5 X 32,5 CM  
20 IN<sup>7/8</sup> X 12 IN<sup>13/16</sup>

**230753**  
**GN 2/3**  
35,4 X 32,5 CM  
13 IN<sup>15/16</sup> X 12 IN<sup>13/16</sup>

ACRYLIQUE ÉPAISSEUR 1 CM  
ACRYLIC THICKNESS IN<sup>3/8</sup>

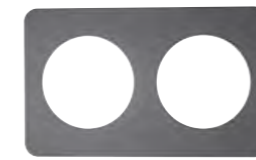

**230756**  
**GN 1/1 - 2 TROUS**  
2 HOLES  
53,5 X 32,5 CM - 20 IN<sup>7/8</sup> X 12 IN<sup>13/16</sup>

**230757**  
**GN 1/3 - 2 TROUS - BOLS 14 CM**  
2 HOLES - BOWLS 5,5 IN  
17,5 X 32,5 CM - 6 IN<sup>7/8</sup> X 12 IN<sup>13/16</sup>



COMPATIBLES AVEC BOLS  
AVAILABLE WITH BOWLS

**136529**  
24 CM - 9 IN<sup>7/16</sup>  
CONTENANCE : 2 L  
CAPACITY : 67 OZ<sup>5/8</sup>  
H : 11 CM - 4 IN<sup>1/4</sup>

**136511**  
20 CM - 7 IN<sup>7/8</sup>  
CONTENANCE : 1,30 L  
CAPACITY : 43 OZ<sup>15/16</sup>  
H : 9,5 CM - 3 IN<sup>3/4</sup>

GRÈS ONYX<sup>(2)</sup>  
GREY STONEWARE



**234550 - 245097 NEW**  
**GN 2/3**  
35,4 X 32,5 CM  
13 IN<sup>15/16</sup> X 12 IN<sup>13/16</sup>

**245098**  
**GN 1/3**  
17,5 X 32,5 CM  
6 IN<sup>7/8</sup> X 12 IN<sup>13/16</sup>



PLATEAU **234556 - 245099 NEW**  
**À REBORDS** **GN 1/3**  
EDGE TRAY 17,5 X 32,5 CM  
6 IN<sup>7/8</sup> X 12 IN<sup>13/16</sup>

PORCELAINE<sup>(2)</sup>  
WHITE ENAMELLED PORCELAIN



**202628**  
**GN 2/3**  
35,4 X 32,5 CM  
13 IN<sup>15/16</sup> X 12 IN<sup>13/16</sup>

**202629**  
**GN 1/2**  
26,4 X 32,5 CM  
10 IN<sup>3/8</sup> X 12 IN<sup>13/16</sup>

**202627**  
**GN 1/3**  
17,5 X 32,5 CM  
6 IN<sup>7/8</sup> X 12 IN<sup>13/16</sup>



PLAT CREUX **202630**  
**PORCELAINE** **GN 1/3**  
PORCELAIN 17,5 X 32,5 CM  
DEEP DISH 6 IN<sup>7/8</sup> X 12 IN<sup>13/16</sup>

(1) Compatible lave-vaisselle, NON compatible micro-ondes  
Dish washer safe, DONT USE with micro-wave

(2) Garantie lave-vaisselle, Garantie micro-ondes  
Dish washer safe, Microwave safe

## URNES À JUS DE FRUITS\* FRUIT JUICE URNS

Urne à jus de fruit dotée d'un tube central en acier pour glace pilée : parfait maintien de la fraîcheur  
Fruit juice urn with central steel tube to hold crushed ice, for perfect freshness



**FINITION MIROIR**  
MIRROR FINISH

**FINITION BROSSÉE**  
BRUSHED FINISH

**URNE À JUS DE FRUITS 4L**  
**ACIER 18-10**  
JUICE DISPENSER 135 OZ  
STAINLESS STEEL

**231303**  
L 20 CM X P 32 CM X H 45 CM  
W 7 IN<sup>7/8</sup> X D 12 IN<sup>5/8</sup> X H 17 IN<sup>11/16</sup>

**231304**  
L 20 CM X P 32 CM X H 45 CM  
W 7 IN<sup>7/8</sup> X D 12 IN<sup>5/8</sup> X H 17 IN<sup>11/16</sup>

## DISTRIBUTEURS À CÉRÉALES\* CEREAL DISPENSERS

Distributeur à céréales 1 ou 3 tubes avec ailettes souples pour ne pas casser les céréales  
Cereal dispenser 1 or 3 tubs with flexible spout so as not to break the cereals



X3

**DISTRIBUTEUR À CÉRÉALES 231300**  
CEREAL DISPENSER  
L 50 CM X P 20 CM X H 55,5 CM  
W 19 IN<sup>1/16</sup> X D 7 IN<sup>7/8</sup> X H 21 IN<sup>7/8</sup>  
CAPACITÉ : 3 X 3,5 L  
CAPACITY : 3 X 1 GAL



X1

**231299**  
L 19 CM X P 20 CM X H 55,5 CM  
W 7 IN<sup>1/2</sup> X D 7 IN<sup>7/8</sup> X H 21 IN<sup>7/8</sup>  
CAPACITÉ : 3,5 L  
CAPACITY : 1 GAL

**CRISTALLIN SOUFFLÉ BOUCHE**  
HAND BLOWN CRYSTALLINE



**CARAFE À JUS 202639**  
**DE FRUIT - 1,2 L** Ø 10,5 CM - H 27,5 CM  
JUICE/BEVERAGE Ø 4 IN<sup>1/8</sup> X H 10 IN<sup>13/16</sup>  
CARAFE - 40 OZ<sup>9/16</sup>

**PORCELAINE**  
PORCELAIN



**CARAFE 202636**  
**À LAIT - 1,2 L** Ø 10,5 CM - H 27,5 CM  
MILK JUG Ø 4 IN<sup>1/8</sup> X H 10 IN<sup>13/16</sup>  
- 40 OZ<sup>9/16</sup>

Bouchon verseur, pour une meilleure hygiène  
Hygienic pouring stopper



**BOUCHON DE 202855**  
**CARAFE SILICONE** Ø 6,5 CM - H 4,2 CM  
STOPPER FOR Ø 2 IN<sup>9/16</sup> X H 1 IN<sup>5/8</sup>  
CARAFE SILICONE



**RAFRAICHISSEUR 237501**  
**DROIT** Ø 13,9 X H 19,8 CM  
**DOUBLE PARI** Ø 5 IN<sup>7/8</sup> X H 7 IN<sup>13/16</sup>  
CURVED  
DOUBLE WALL  
WINE COOLER



**BOL 154245**  
**PORCELAINE MODULO BLANC**  
PORCELAIN BOWL WHITE MODULO  
14 CM - 5 IN<sup>1/2</sup>

**202626**  
**EMPILABLE**  
STACKABLE



**ETIQUETTE PORCELAINE 202632**  
**AVEC AIMANT** 10 X 5 CM  
**+ SUPPORT ACIER** 3 IN<sup>15/16</sup> X 1 IN<sup>15/16</sup>  
PORCELAIN STICK +  
STAINLESS STEEL STAND  
WITH MAGNET

\*Certaines pièces sont disponibles en pièces détachées  
Some items are available individually



Panière reversible pour une présentation droite ou inclinée  
Reversible basket for a level or titled display



Des supports en acier noir mat de hauteurs différentes pour rythmer les présentations.  
Black mat finish supports of differing heights can be used to create a varied presentation.

**SUPPORTS À FIL RECTANGULAIRES** RECTANGULAR TRAYS



1

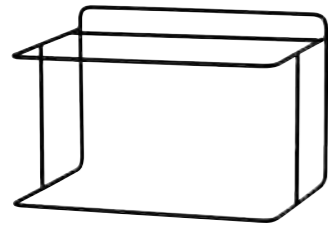

2

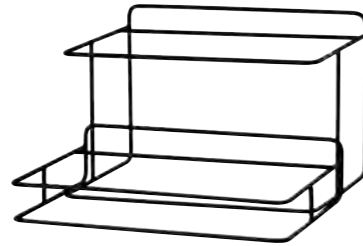

1+2



**PANIÈRE 230749**  
RECTANGULAIRE GN 1/1  
RECTANGULAR 54 X 34 X H 7 CM  
BREAD BASKET 21 IN<sup>1/4</sup> X 13 IN<sup>3/8</sup> X 2 IN<sup>3/4</sup>

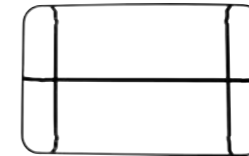

**CADRE ACIER 230744**  
POUR SUPPORT L 55,5 X P 35 X H 4,5 CM  
RECTANGULAIRE<sup>(1)</sup> W 21 IN<sup>7/8</sup> X D 13 IN<sup>3/4</sup> X H 1 IN<sup>3/4</sup>  
STEEL FRAME FOR STAND

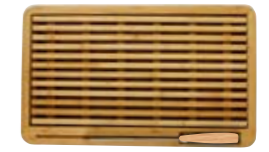

**PLANCHE À PAIN 202854**  
BAMBOU AVEC GN 1/1  
RÉCUPÉRATEUR 53 X 32,5 CM  
DE MIETTES 20 IN<sup>7/8</sup> X 12 IN<sup>13/16</sup>  
BAMBOO BREAD BOARD  
WITH CRUMB TRAY

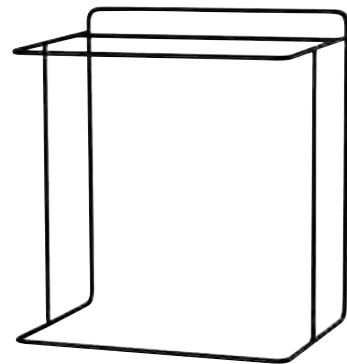

3

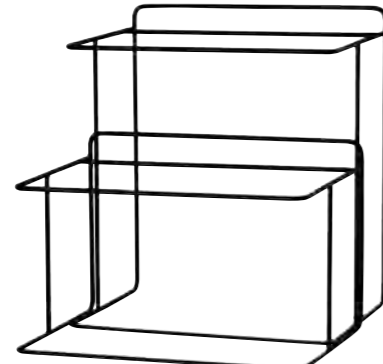

2+3



1+2+3

**SUPPORT 230741**  
RECTANGULAIRE NIVEAU 1  
RECTANGULAR TRAY LEVEL 1  
L 44 X P 30,8 X H 10,8 CM  
W 17 IN<sup>5/16</sup> X D 12 IN<sup>1/8</sup> X H 4 IN<sup>1/4</sup>

**230742**  
NIVEAU 2  
LEVEL 2  
L 42 X P 30,8 X H 29,8 CM  
W 16 IN<sup>5/16</sup> X D 12 IN<sup>1/8</sup> X H 11 IN<sup>3/4</sup>

**230743**  
NIVEAU 3  
LEVEL 3  
L 40 X P 30,8 X H 48,8 CM  
W 15 IN<sup>3/4</sup> X D 12 IN<sup>1/8</sup> X H 19 IN<sup>3/16</sup>

**230741 + 230742**  
NIVEAU 1+2  
LEVEL 1+2  
L 44 X P 50 X H 29,8 CM  
W 17 IN<sup>5/16</sup> X D 19 IN<sup>11/16</sup> X H 11 IN<sup>3/4</sup>

**230742 + 230743**  
NIVEAU 2+3  
LEVEL 2+3  
L 42 X P 50 X H 48,8 CM  
W 16 IN<sup>5/16</sup> X D 19 IN<sup>11/16</sup> X H 19 IN<sup>3/16</sup>

**230741 + 230742 + 230743**  
NIVEAU 1+2+3  
LEVEL 1+2+3  
L 44 X P 68,2 X H 48,8 CM  
W 17 IN<sup>5/16</sup> X D 26 IN<sup>7/8</sup> X H 19 IN<sup>3/16</sup>

**MÉLAMINE BOIS<sup>(2)</sup>**  
WOOD MELAMINE TRAY



**PLATEAUX 234546**  
TRAYS GN1/1  
53,5 X 32,5 CM  
20 IN<sup>7/8</sup> X 12 IN<sup>13/16</sup>

**MÉLAMINE PIERRE<sup>(2)</sup>**  
STONE MELAMINE TRAY



**234547**  
GN1/1  
53,5 X 32,5 CM  
20 IN<sup>7/8</sup> X 12 IN<sup>13/16</sup>

**ACIER 18/10 NEWPORT**  
FINITION MIROIR  
SERVING TRAY STAINLESS STEEL  
18/10 MIRROR FINISHED



**238962**  
GN1/1  
53,5 X 32,5 CM  
20 IN<sup>7/8</sup> X 12 IN<sup>13/16</sup>

**VERRE ÉPAISSEUR 0,6 CM**  
TEMPERED GLASS THICKNESS 1/4"



**230752**  
GN1/1  
53,5 X 32,5 CM  
20 IN<sup>7/8</sup> X 12 IN<sup>13/16</sup>

**SUPPORTS À FIL ROUNDS** ROUND TRAYS

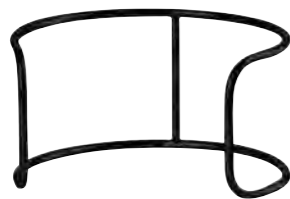

**SUPPORT 230745**  
ROND BAS - LOW LEVEL  
ROUND STAND Ø 25 CM X H 13 CM  
Ø 9 IN<sup>13/16</sup> X H 5 IN<sup>1/8</sup>

**230746**  
HAUT - HIGH LEVEL  
Ø 25 CM X H 26 CM  
Ø 9 IN<sup>13/16</sup> X H 10 IN<sup>1/4</sup>

**GRÈS CARBONE<sup>(1)</sup>**  
GREY STONEWARE



**SALADIER 234564**  
BAS Ø 25,4 X 7 CM - 2,4 L  
SALAD Ø 10 IN X 2 IN<sup>3/4</sup> - 80 OZ<sup>1/8</sup>  
BOWL



**PANIÈRES 230750**  
BREAD BASKETS INDIVIDUELLE-INDIVIDUAL  
Ø 18 CM X 6 CM  
Ø 7 IN<sup>1/16</sup> X 2 IN<sup>3/8</sup>

**230748**  
RONDE-ROUND  
Ø 32 CM X H 8 CM  
Ø 12 IN<sup>5/8</sup> X H 3 IN<sup>1/8</sup>

**MÉLAMINE BOIS<sup>(2)</sup>**  
WOOD MELAMINE TRAY

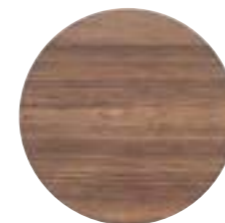

**PLATEAUX ROUNDS 234561**  
ROUND TRAYS Ø 32 CM  
12 IN<sup>5/8</sup>

(1) Compatible lave-vaisselle, Compatible micro-ondes  
Dish washer safe, Micro-wave safe

**MÉLAMINE PIERRE<sup>(2)</sup>**  
STONE MELAMINE TRAY



**234562**  
Ø 32 CM  
12 IN<sup>5/8</sup>

(2) Compatible lave-vaisselle, NON compatible micro-ondes  
Dish washer safe, DONT USE with micro-wave safe



**136524**  
Ø 32 CM  
12 IN<sup>5/8</sup>

**PORCELAINE MODULO**  
MODULO PORCELAIN  
PIE/PIZZA PLATE, FLAT



# BOARDS

CHÊNE  
OAK



**PLANCHE RONDE 242942**  
ROUND BOARD 29,4 CM - 11 IN<sup>9/16</sup>  
EPAISSEUR - 2 CM  
THICKNESS - 1/8 IN



**PLANCHE BAHIA 242941**  
BAHIA BOARD 35 X 21 CM - 13 IN<sup>3/4</sup> X 8 IN<sup>1/4</sup>  
EPAISSEUR - 2 CM  
THICKNESS - 1/8 IN



**PLANCHE CARREE 242940**  
SQUARE BOARD 36,7 X 30 CM - 14 IN<sup>7/16</sup> X 11 IN<sup>13/16</sup>  
EPAISSEUR - 2 CM  
THICKNESS - 1/8 IN



**PLANCHE ALLONGEE 242939**  
LONG BOARD 50 X 21 CM - 19 IN<sup>11/16</sup> X 8 IN<sup>1/4</sup>  
EPAISSEUR - 2 CM  
THICKNESS - 1/8 IN

NOYER  
WALNUT



**PLANCHE RONDE 242946**  
ROUND BOARD 29,4 CM - 11 IN<sup>9/16</sup>  
EPAISSEUR - 2 CM  
THICKNESS - 1/8 IN



**PLANCHE BAHIA 242945**  
BAHIA BOARD 35 X 21 CM - 13 IN<sup>3/4</sup> X 8 IN<sup>1/4</sup>  
EPAISSEUR - 2 CM  
THICKNESS - 1/8 IN



**PLANCHE CARREE 242944**  
SQUARE BOARD 36,7 X 30 CM - 14 IN<sup>7/16</sup> X 11 IN<sup>13/16</sup>  
EPAISSEUR - 2 CM  
THICKNESS - 1/8 IN



**PLANCHE ALLONGEE 242943**  
LONG BOARD 50 X 21 CM - 19 IN<sup>11/16</sup> X 8 IN<sup>1/4</sup>  
EPAISSEUR - 2 CM  
THICKNESS - 1/8 IN

COMPATIBLE AVEC  
LA CLOCHE EVENTO 239771  
COMPATIBLE WITH  
EVENTO DOME COVER

# PLANCHES LES ESSENCES

MADE IN FRANCE







**SALADIER 142722**  
**PORCELAINE** 28 CM - 11 IN  
**MODULO** H : 12 CM - 4 IN<sup>3/4</sup>  
 DEEP SALAD BOWL, LARGE CAPACITY : 2,5 L  
 CONTENANCE : 84 OZ<sup>3/16</sup>



**PRÉSENTOIR 209381**  
**À GÂTEAUX ROND** Ø 25 CM - 9 IN<sup>13/16</sup>  
 ROUND APP/PIZZA/  
 PRESENTATION STAND  
**209382**  
 Ø 32 CM - 12 IN<sup>5/16</sup>



**CLOCHE 239769**  
**EVENTO VERRE** Ø 16 CM - 6 IN<sup>5/16</sup>  
 EVENTO  
**239770**  
**DOME COVER** Ø 23 CM - 9 IN<sup>1/16</sup>  
**239771**  
 Ø 28 CM - 11 IN



**SUPPORT COUVERTS 202633**  
**DE SERVICE** 21 X 10 X 5 CM  
**PORCELAINE** 8 IN<sup>1/4</sup> X 3 IN<sup>15/16</sup> X 1 IN<sup>15/16</sup>  
 SERVING  
 CUTLERY DISPLAY  
 WHITE PORCELAIN



**ETIQUETTE 202632**  
**PORCELAINE** 10 X 5 CM  
**AVEC AIMANT** 3 IN<sup>15/16</sup> X 1 IN<sup>15/16</sup>  
**+ SUPPORT ACIER**  
 PORCELAIN STICK +  
 STAINLESS STEEL STAND  
 WITH MAGNET

**MÉLAMINE BOIS<sup>(2)</sup>**  
 WOOD MELAMINE TRAY



**(1) PLANCHA 234559**  
**AVEC MANCHE** 17,5 X 45 CM  
 BOARD 6 IN<sup>7/8</sup> X 17 IN<sup>11/16</sup>

**MÉLAMINE PIERRE<sup>(2)</sup>**  
 STONE MELAMINE TRAY



**234560**  
 17,5 X 45 CM  
 6 IN<sup>7/8</sup> X 17 IN<sup>11/16</sup>



**CISEAUX 204496**  
**À GÂTEAUX** 101494  
 PASTRY  
 SCISSORS/TONG 20 CM - 7 IN<sup>7/8</sup>



**PINCE À SERVIR 204499**  
 SERVING TONG 184355  
 29,5 CM - 11 IN<sup>5/8</sup>



**PINCE À PAIN 204498**  
 BREAD TONG 101492  
 23 CM - 9 IN<sup>1/16</sup>



**LOUCHE 153193**  
 SOUP LADLE **ASTRÉE MIROIR**  
 29,7 CM - 11 IN<sup>11/16</sup>

(1) Planche de présentation uniquement, ne pas faire de découpe  
 Presentation board, dont cut on it

(2) Compatible lave-vaisselle, NON compatible micro-ondes  
 Dish washer safe, DONT USE with micro-wave

**PIERRE DE LUNE**  
 MOONSTONE  
 Porcelaine - Porcelain



**SALADIER 239325**  
 BOWL 28 CM - 11 IN  
 4L - 135 OZ<sup>1/4</sup>

**DUNE**  
 BEIGE DUNE  
 Grès - Stoneware



**235223**  
 28 CM - 11 IN  
 4L - 135 OZ<sup>1/4</sup>

**BLEU DE ROCHE**  
 BLUE STONE  
 Grès - Stoneware



**235222**  
 28 CM - 11 IN  
 4L - 135 OZ<sup>1/4</sup>

**ONYX**  
 BLACK ONYX  
 Grès - Stoneware



**240499**  
 28 CM - 11 IN  
 4L - 135 OZ<sup>1/4</sup>

**ARGILE VERTE**  
 GREEN CLAY  
 Grès - Stoneware



**234949**  
 25 X 13,5 CM  
 9 IN<sup>13/16</sup> X 5 IN<sup>5/16</sup>



**PLANCHE 242054**  
**RECTANGULAIRE** 35 x 21 CM  
 RECTANGULAR BOARD 13 IN<sup>3/4</sup> x 8 IN<sup>1/4</sup>



**242056**  
 35 x 21 CM  
 13 IN<sup>3/4</sup> x 8 IN<sup>1/4</sup>



**242052**  
 35 x 21 CM  
 13 IN<sup>3/4</sup> x 8 IN<sup>1/4</sup>



**237206**  
 25 X 13,5 CM  
 9 IN<sup>13/16</sup> X 5 IN<sup>5/16</sup>



**PLANCHE 242055**  
**RONDE** 29 CM - 11 IN<sup>7/16</sup>  
 ROUND BOARD



**242057**  
 29 CM - 11 IN<sup>7/16</sup>



**242053**  
 29 CM - 11 IN<sup>7/16</sup>



**PLAT 241835**  
**GRAND MODÈLE** 31,8 x 25 x 7,4 CM  
 LARGE DISH 12 IN<sup>1/2</sup> x 9 IN<sup>13/16</sup> x 2 IN<sup>15/16</sup>

**PLAT 241834**  
**MOYEN MODÈLE** 22,8 x 16,2 x 5,4 CM  
 MEDIUM DISH 9 IN x 6 IN<sup>3/8</sup> x 2 IN<sup>1/8</sup>

**PLAT 241833**  
**PETIT MODÈLE** 15,5 x 10,7 x 4,4 CM  
 SMALL DISH 6 IN<sup>7/8</sup> x 4 IN<sup>3/16</sup> x 1 IN<sup>3/4</sup>



**237595**  
 31,8 x 25 x 7,4 CM  
 12 IN<sup>1/2</sup> x 9 IN<sup>13/16</sup> x 2 IN<sup>15/16</sup>

**237594**  
 22,8 x 16,2 x 5,4 CM  
 9 IN x 6 IN<sup>3/8</sup> x 2 IN<sup>1/8</sup>

**237593**  
 15,5 x 10,7 x 4,4 CM  
 6 IN<sup>7/8</sup> x 4 IN<sup>3/16</sup> x 1 IN<sup>3/4</sup>

# PLAN

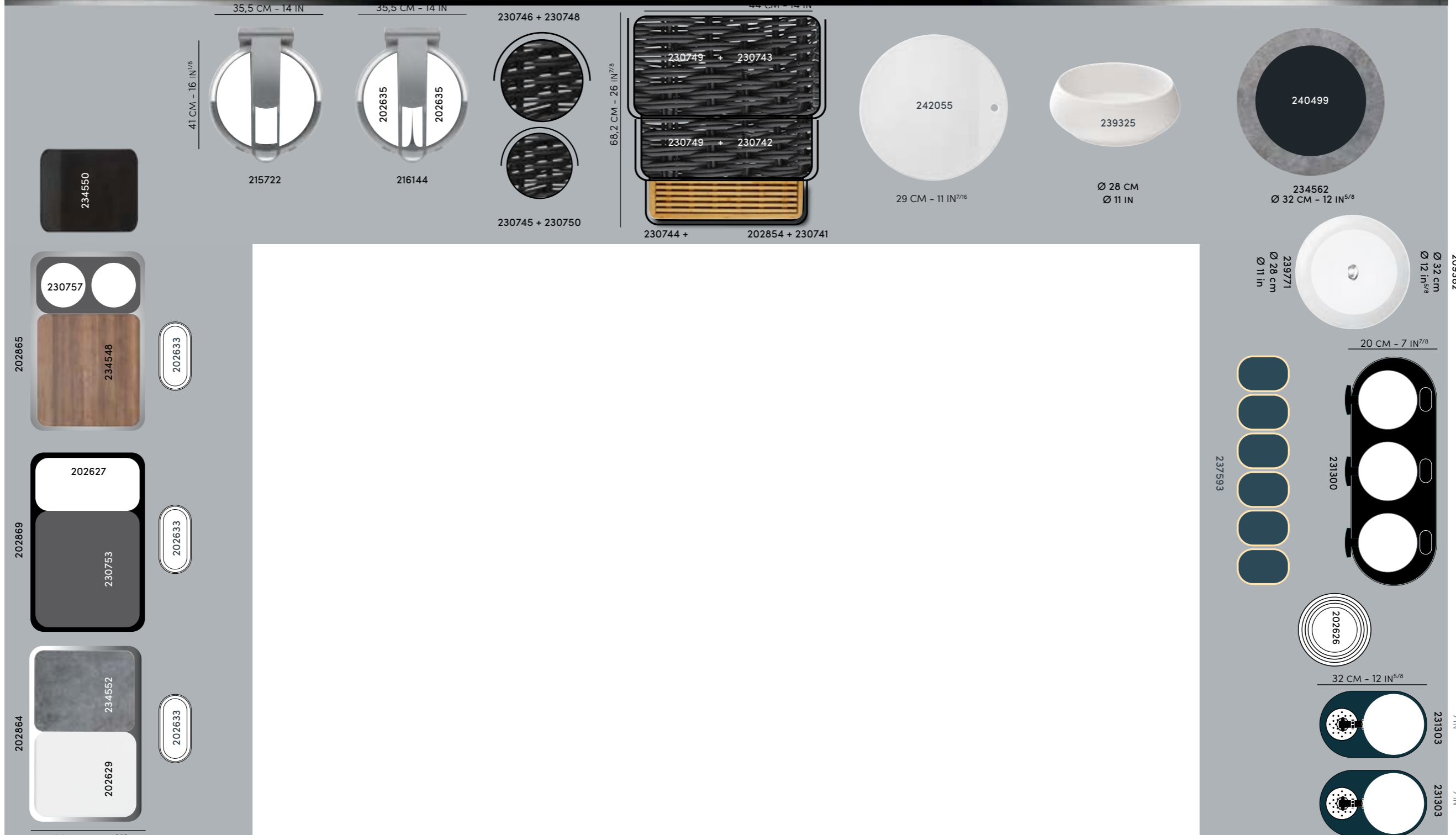

# PIÈCES DÉTACHÉES

## CHAFING DISH

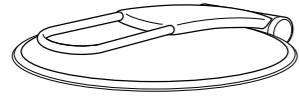

**COUVERCLE AVEC GOUTTIÈRE** 203470  
**ACIER ET VERRE TREMPÉ**  
 LID WITH STAINLESS STEEL  
 GUTTER,  
 TEMPERED GLASS

**JOINT POUR CHAFING DISH** 230050  
 SEAL FOR CHAFING DISH

## MODULE FROID REFRIGERATED UNIT



**BAC PLASTIQUE** 202866  
 PLASTIC TRAY  
 56 X 35,5 X 8 CM  
 22 IN<sup>1/16</sup> X 14 IN X 3 IN<sup>1/8</sup>

**235357**  
 29,5 X 35,6 CM  
 11 IN<sup>5/8</sup> X 14 IN

## URNE À JUS DE FRUITS FRUIT JUICE URN

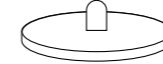

**COUVERCLE URNE** 202881  
**ACIER 18-10**  
 LID FOR STAINLESS  
 DISPENSER 18-10

**202891**  
**FINITION MIROIR**  
 MIRROR FINISH  
 Ø 17,9 CM  
 7 IN<sup>1/16</sup>

**202891**  
**FINITION BROSSÉE**  
 BRUSHED FINISH  
 Ø 17,9 CM  
 7 IN<sup>1/16</sup>

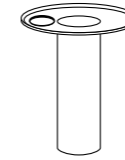

**TUBE ACIER POUR** 202884  
**GLACE**  
 ICE TUBE  
 STAINLESS STEEL

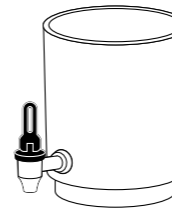

**FÛT CYLINDRIQUE** 202883  
**URNE**  
 CONTAINER FOR  
 DISPENSER

5 L - 169 OZ<sup>1/16</sup>  
 Ø 17,7 CM X H 25,5 CM  
 Ø 6 IN<sup>15/16</sup> X H 10 IN<sup>1/16</sup>

**ROBINET ACIER** 214724  
**ABS NOIR**  
 STAINLESS STEEL  
 FAUCET BLACK

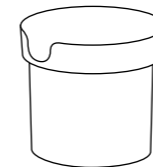

**BASE ACIER** 202890  
**18-10 URNE**  
 STAINLESS STEEL  
 STAND FOR  
 DISPENSER 18-10

**202890**  
**FINITION MIROIR**  
 MIRROR FINISH  
 Ø 17,6 CM - H 19 CM  
 6 IN<sup>15/16</sup> X 7 IN<sup>1/2</sup>

**202889**  
**FINITION BROSSÉE**  
 BRUSHED FINISH  
 Ø 17,6 CM - H 19 CM  
 6 IN<sup>15/16</sup> X 7 IN<sup>1/2</sup>

**GRILLE ACIER** 045963  
**POUR GOUTTES - 18/10**  
 STAINLESS STEEL GRID  
 DROP COLLECTOR



**SOCLE NOIR ACRYLIQUE URNE** 230758  
 STAND FOR BLACK DISPENSER  
 20 X 32 CM  
 7 IN<sup>2/8</sup> X 12 IN<sup>5/8</sup>  
 ÉPAISSEUR : 2 CM  
 THICKNESS: 13/16 IN

## DISTRIBUTEUR À CÉRÉALES CEREAL DISPENSER



**COUVERCLE** 213078  
**DISTRIBUTEUR CEREALES**  
**ACIER FINITION MIROIR - 18/10**  
 LID FOR CEREAL DISPENSER,  
 STAINLESS STEEL,  
 MIRROR FINISH

Ø 12,5 CM  
 Ø 4 IN<sup>5/16</sup>

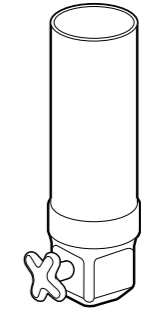

**FUT CYLINDRIQUE** 213076  
**AVEC AILETTE ET POIGNEE**  
**DISTRIBUTEUR CEREALES**  
 BARREL + HANDLE + ROLLING TAP  
 FOR CEREAL DISPENSER

P 16,1 X H 42 CM  
 D 6 IN<sup>9/16</sup> X H 16 IN<sup>9/16</sup>

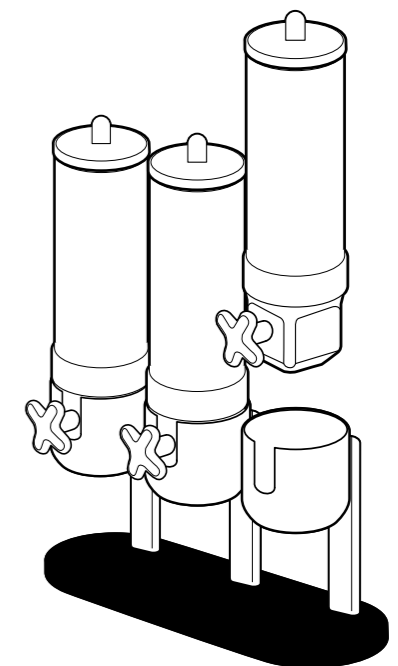

X3

X1

**BASE + TUBE + SOCLE** 231302  
**DISTRIBUTEUR À CEREALES**  
 STAINLESS STEEL STAND + TUB  
 + ACRYLIC STAND FOR CEREAL  
 DISPENSER

L 50 X H 27,5 CM  
 L 19 IN<sup>11/16</sup> X H 29 IN<sup>3/4</sup>

**231301**  
 L 19 X H 27,5 CM  
 L 7 IN<sup>1/2</sup> X H 29 IN<sup>3/4</sup>



Pensée initialement pour répondre aux besoins des collectivités, la nouvelle collection GD revisite avec finesse ses gammes de couverts et platerie Made In France et celles de vaisselle Made in Europe . Chaque pièce évoque discrètement ce mélange entre héritage et exigences contemporaines : des formes simples, des détails subtils, et un usage fonctionnel. Le tout avec le marquage DEGRENNE, véritable gage de qualité. En mariant judicieusement des formes issues de nos archives à une approche moderne, cette collection s'inscrit dans une démarche éco-responsable et devient un choix idéal pour tout établissement à la recherche d'une touche de rétro.

Originally designed to meet the needs of communities, the new GD collection delicately reimagines its ranges of Made In France cutlery and tableware, as well as those of Made in Europe dinnerware. Each piece subtly reflects the blend of heritage and contemporary requirements: simple shapes, subtle details, and functional use. All of this comes with the DEGRENNE branding, a true mark of quality.

By skillfully combining shapes from our archives with a modern approach, this collection embraces an eco-responsible approach and becomes an ideal choice for establishments seeking a touch of retro.



169511  
**FOURCHETTE DE TABLE**  
TABLE FORK  
19,9 CM - 7 IN<sup>13/16</sup>



169513  
**COUTEAU À STEAK  
MONOBLOC LAME SCIE**  
STEAK KNIFE SOLID HANDLE SERRATED  
22,3 CM - 8 IN<sup>3/4</sup>



169510  
**CUILLÈRE DE TABLE**  
TABLE/PASTA SPOON  
20,1 CM - 7 IN<sup>15/16</sup>



184372  
**FOURCHETTE À DESSERT/POISSON**  
DESSERT/SALAD/FISH FORK  
17,9 CM - 7 IN<sup>1/16</sup>



184374  
**CUILLÈRE À DESSERT**  
DESSERT/SOUP SPOON, OVAL  
18 CM - 7 IN<sup>1/16</sup>



184371  
**COUTEAU À DESSERT  
MONOBLOC LAME UNIE**  
DESSERT KNIFE SOLID HANDLE  
19,8 CM - 7 IN<sup>13/16</sup>



169512  
**CUILLÈRE À CAFÉ**  
COFFEE/TEA SPOON  
13,6 CM - 5 IN<sup>1/4</sup>

Bar

136123  
**LOT DE 12 CUILLÈRES MOKA**  
BATCH OF 12 DEMI TASSE SPOONS  
10,8 CM - 4 IN<sup>1/4</sup>

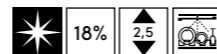



**193762**  
**FOURCHETTE DE TABLE**  
TABLE FORK  
20 CM - 7 IN<sup>11/16</sup>



**193764**  
**COUTEAU DE TABLE**  
**MONOBLOC LAME SCIE**  
TABLE KNIFE SOLID HANDLE SERRATED  
23,2 CM - 9 IN<sup>1/8</sup>



**193761**  
**CUILLÈRE DE TABLE**  
TABLE/PASTA SPOON  
20,2 CM - 7 IN<sup>15/16</sup>



**195773**  
**FOURCHETTE À DESSERT**  
DESSERT/SALAD FORK  
17,9 CM - 7 IN<sup>11/16</sup>



**195772**  
**CUILLÈRE À DESSERT**  
DESSERT/SOUP SPOON, OVAL  
17,8 CM - 7 IN



**195774**  
**COUTEAU À DESSERT**  
**MONOBLOC LAME UNIE**  
DESSERT KNIFE SOLID HANDLE  
20,2 CM - 7 IN<sup>15/16</sup>



**193763**  
**CUILLÈRE À CAFÉ**  
COFFEE/TEA SPOON  
13,6 CM - 5 IN<sup>3/8</sup>



**198323**  
**CUILLÈRE MOKA**  
DEMI TASSE SPOON  
11 CM - 4 IN<sup>5/16</sup>

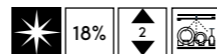



MADE IN EUROPE



**ASSIETTE 216531**  
**PLATE** 12 CM - 4 IN<sup>3/4</sup>  
**RONDE**  
 ROUND  
 PLATE



**ASSIETTE 216530**  
**À SALADE** 20 CM - 7 IN<sup>7/8</sup>  
**RONDE**  
 ROUND  
 SALAD  
 PLATE



**ASSIETTE 216532**  
**OBLONGUE** 19 X 32 CM - 7 IN<sup>1/2</sup> X 12 IN<sup>5/8</sup>  
**PLATE** **216533**  
 12 X 20 CM - 4 IN<sup>3/4</sup> X 7 IN<sup>7/8</sup>



**ASSIETTE 216536**  
**À CREME BRULEE** 15 CM - 5 IN<sup>7/8</sup>  
 CREME BRULEE  
 ROUND PLATE



**COUPELLE 216535**  
**RONDE** 14 CM - 5 IN<sup>1/2</sup>  
 ROUND  
**DEEP 216534**  
**PLATE** 12 CM - 4 IN<sup>3/4</sup>  
 20 CL - 7 OZ<sup>7/8</sup>



**PLAT À GRATIN 198935**  
**ROND** 14 CM - 5 IN<sup>1/2</sup>  
 ROUND  
 CASSEROLE  
 PLATE



**GOBELET 198936**  
**ROND** 9 CM - 3 IN<sup>9/16</sup>  
 ROUND CUP



GLORIA



MADE IN EUROPE



**ASSIETTE 194112**  
**PLATE 26 CM - 10 IN<sup>1/4</sup>**  
 DINNER PLATE



**ASSIETTE 194115**  
**DESSERT 20 CM - 7 IN<sup>7/8</sup>**  
 ROUND  
 DESSERT  
 PLATE



**ASSIETTE 194113**  
**CREUSE 22 CM - 8 IN<sup>11/16</sup>**  
 ROUND  
 SOUP PLATE **194114**  
 19 CM - 7 IN<sup>1/2</sup>



**ASSIETTE 194116**  
**À PAIN 15 CM - 5 IN<sup>7/8</sup>**  
 ROUND  
 BREAD & BUTTER  
 PLATE



**PLAT ROND PLAT 194110**  
 ROUND DISH 30 CM - 11 IN<sup>3/16</sup>



**PLAT OVALE 194122**  
 OVAL DISH 36 CM - 14 IN<sup>3/16</sup>  
**194123**  
 28 CM - 11 IN



**PLAT 194121**  
**À CAKE 40x13 CM - 15<sup>3/4</sup>x5<sup>1/8</sup>**  
 RECTANGULAR  
 CAKE DISH



**BOL 194120**  
 BOWL 13 CM - 5 IN<sup>1/8</sup>



**SAUCIERE 194139**  
 SAUCE JUG 20 CL - 6 OZ<sup>3/4</sup>



**CREMIER 194137**  
 CREAM JUG 10 CL - 3 OZ<sup>3/8</sup>



**TASSE À ESPRESSO 194125**  
 ESPRESSO CUP 9 CL - 3 OZ<sup>1/16</sup>



**TASSE À CAFÉ 194126**  
 DEMITASSE CUP 18 CL - 6 OZ<sup>1/16</sup>



**TASSE À THÉ 194127**  
 COFFEE/TEA CUP 26 CL - 8 OZ<sup>13/16</sup>

**SOUCOPE À ESPRESSO 194129**  
 ESPRESSO SAUCER 13 CM - 5 IN<sup>1/8</sup>

**SOUCOPE À CAFÉ 194130**  
 DEMITASSE SAUCER 14 CM - 5 IN<sup>1/2</sup>

**SOUCOPE À THÉ 194131**  
 COFFEE/TEA SAUCER 16 CM - 6 IN<sup>7/16</sup>







**ASSIETTE 109343**  
**PLATE** 26,5 CM - 10 IN<sup>3/7</sup>  
 ROUND  
 DINNER PLATE **109338**  
 24 CM - 9 IN<sup>4/9</sup>  
**109340**  
 19 CM - 7 IN<sup>1/2</sup>



**ASSIETTE 109339**  
**CREUSE** 22 CM - 8 IN<sup>2/3</sup>  
 ROUND  
 SOUP PLATE



**ASSIETTE 109344**  
**À PAIN** 16 CM - 6 IN<sup>2/7</sup>  
 ROUND  
 BREAD & BUTTER  
 PLATE



**TASSE À DÉJEUNER 054303**  
 BREAKFAST CUP 28 CL - 9 OZ<sup>7/16</sup>  
**SOUCOUPE À DÉJEUNER 054308**  
 BREAKFAST SAUCER 16 CM - 6 IN<sup>2/7</sup>



**TASSE À THÉ 054301**  
 COFFEE/TEA CUP 16 CL - 5 OZ<sup>7/16</sup>  
**SOUCOUPE À THÉ 054302**  
 COFFEE/TEA SAUCER 15 CM - 5 IN<sup>7/8</sup>



**TASSE À MOKA 109341**  
 MOKA CUP 10 CL - 3 OZ<sup>3/8</sup>  
**SOUCOUPE À MOKA 109342**  
 MOKA SAUCER 13 CM - 5 IN<sup>1/8</sup>



UNISET



MADE IN EUROPE



VITAL



MADE IN EUROPE



**ASSIETTE 223287**  
PLATE 30 CM - 11 IN<sup>7/8</sup>  
ROUND  
DINNER PLATE **223286**  
26,5 CM - 10 IN<sup>3/7</sup>  
**223285**  
20 CM - 7 IN<sup>7/8</sup>



**ASSIETTE 223288**  
CREUSE 19 CM - 7 IN<sup>1/2</sup>  
ROUND  
SOUP PLATE



**ASSIETTE 223294**  
À PIZZA 30 CM - 11 IN<sup>7/8</sup>  
PIZZA PLATE



**ASSIETTE 223363**  
À PAIN 15 CM - 5 IN<sup>7/8</sup>  
ROUND  
BREAD & BUTTER  
PLATE



**MUG 223293**  
MUG 30 CL - 10 OZ



**TASSE À THÉ 223291**  
COFFEE/TEA CUP 20 CL - 6 OZ<sup>3/4</sup>  
**SOUCOUBE À THÉ 223292**  
COFFEE/TEA SAUCER 15 CM - 5 IN<sup>7/8</sup>



**TASSE À CAFÉ 223289**  
DEMITASSE CUP 10 CL - 3 OZ<sup>3/8</sup>  
**SOUCOUBE À CAFÉ 223290**  
DEMITASSE SAUCER 12 CM - 4 IN<sup>3/4</sup>



## PLATEAUX TRAYS



**PLATEAU COMPARTIMENTÉ 240688**  
COMPARTIMENTALISED SERVING TRAY 39,5 X 29,5 CM - 15 IN<sup>5/16</sup> X 11 IN<sup>5/16</sup>



**PLATEAU ALVÉOLÉ MATERNELLE 242663**  
ALVEOLE TRAY FOR NURSERY SCHOOL 33,5 X 24,6 CM - 13 IN<sup>3/16</sup> X 9 IN<sup>11/16</sup>



## POTS À VERSER EMPILABLES STACKABLE WATER JUGS



**POT À VERSER 003968**  
2 L - 12 X 17 CM - 67 OZ<sup>5/8</sup> - 4 IN<sup>3/4</sup> X 6 IN<sup>11/16</sup>  
**EMPILABLE**  
**STACKABLE**  
**WATER JUG 003967**  
1,5 L - 10,5 X 16 CM - 50 OZ<sup>3/4</sup> - 4 IN<sup>1/8</sup> X 6 IN<sup>5/16</sup>

**003966**  
1 L - 9,5 X 13,5 CM - 33 OZ<sup>13/16</sup> - 3 IN<sup>3/4</sup> X 5 IN<sup>5/16</sup>



## POTS À VERSER UNI LOURD WATER JUGS



**POT À VERSER 004042**  
WATER JUG 2 L - 12,5 X 19 CM - 67 OZ<sup>5/8</sup> - 4 IN<sup>5/16</sup> X 7 IN<sup>1/2</sup>

**004041**  
1,5 L - 11 X 17,5 CM - 50 OZ<sup>3/4</sup> - 4 IN<sup>5/16</sup> X 6 IN<sup>7/8</sup>

**004040**  
1 L - 9,5 X 15 CM - 33 OZ<sup>13/16</sup> - 3 IN<sup>3/4</sup> X 5 IN<sup>7/8</sup>

**004039**  
0,5 L - 7 X 10 CM - 16 OZ<sup>5/16</sup> - 2 IN<sup>3/4</sup> X 5 IN<sup>5/16</sup>

**VISUELS NON CONTRACTUELS**  
NON CONTRACTUAL VISUALS



UNI



MADE IN FRANCE

## PLATS À GRATIN RECTANGULAR GRATIN DISH



**PLAT 003940**  
**À GRATIN** 45 X 31,5 CM - 17 IN<sup>11</sup>/<sub>16</sub> X 12 IN<sup>3</sup>/<sub>8</sub>  
**RECTANGULAIRE**  
**003941**  
 RECTANGULAR  
 GRATIN DISH 37 X 25 CM - 14 IN<sup>3</sup>/<sub>16</sub> X 9 IN<sup>13</sup>/<sub>16</sub>

## PLATS À GRATIN OVALES OVAL GRATIN DISHES



**PLAT 003939**  
**À GRATIN** 38 X 28 CM - 14 IN<sup>15</sup>/<sub>16</sub> X 11 IN  
**OVALE**  
**003937**  
 OVALGRATIN DISH 24 X 15 CM - 9 IN<sup>7</sup>/<sub>16</sub> X 5 IN<sup>7</sup>/<sub>8</sub>

## SOUPIÈRES SOUP TUREEN



**SOUPIÈRE 003971**  
**SANS COUVERCLE** 24 X 9,5 CM - 9 IN<sup>7</sup>/<sub>16</sub> X 3 IN<sup>3</sup>/<sub>4</sub>  
 SOUP TUREEN 270 CL - 91 OZ<sup>2</sup>/<sub>16</sub>  
**003970**  
 WITHOUT LID 22 X 9,5 CM - 8 IN<sup>1</sup>/<sub>16</sub> X 3 IN<sup>3</sup>/<sub>4</sub>  
 220 CL - 74 OZ<sup>2</sup>/<sub>16</sub>  
**003969**  
 20 X 8,5 CM - 7 IN<sup>7</sup>/<sub>8</sub> X 3 IN<sup>3</sup>/<sub>8</sub>  
 170 CL - 57 OZ<sup>2</sup>/<sub>16</sub>



UNI



MADE IN FRANCE

## PLATS À ESCARGOTS SNAIL DISHES



**PLAT À ESCARGOTS 003935**  
**12 PLACES** 20 CM - 9 IN<sup>11</sup>/<sub>16</sub>  
 SNAIL DISH 12 HOLES  
**6 PLACES 003934**  
 SNAIL DISH 6 HOLES 14,5 CM - 6 IN<sup>1</sup>/<sub>2</sub>

## CORBEILLES À PAIN BREAD BASKETS



**CORBEILLE À PAIN 003919**  
**CANNELÉE** 31 X 21 CM - 12 IN<sup>3</sup>/<sub>16</sub> X 8 IN<sup>1</sup>/<sub>4</sub>  
 FLUTED  
**003918**  
 BREAD BASKET 26 X 18 CM - 10 IN<sup>1</sup>/<sub>4</sub> X 7 IN<sup>1</sup>/<sub>8</sub>

## RAMEQUIN RAMEKIN



**RAMEQUIN 003975**  
 RAMEKIN 8 CM - 3 IN<sup>1</sup>/<sub>8</sub>  
 19 CL - 6 OZ<sup>2</sup>/<sub>16</sub>



## PLATEAUX RECTANGULAIRES RECTANGULAR SERVING TRAYS



**PLATEAU 003929**  
**RECTANGULAIRE AVEC ANSES** 45 X 31,5 CM - 17 IN<sup>11/16</sup> X 12 IN<sup>3/8</sup>  
 RECTANGULAR SERVING TRAY WITH HANDLES



**PLATEAU 003930**  
**RECTANGULAIRE SANS ANSES** 45 X 31,5 CM - 17 IN<sup>11/16</sup> X 12 IN<sup>3/8</sup>  
 RECTANGULAR SERVING TRAY WITHOUT HANDLES

## PLATEAU ROND ROUND SERVING TRAY



**PLATEAU 044811**  
**LIMONADIER** 40 CM - 15 IN<sup>3/4</sup>  
 ROUND SERVING TRAY



**PLAT 003951**  
**ROND PLAT** 33 CM - 13 IN  
 ROUND FLAT DISH

## PLATS TRAYS



**PLAT 003947**  
**OVALE** 46 X 31 CM - 18 IN<sup>11/8</sup> X 12 IN<sup>3/8</sup>  
 OVALE DISH

**003945**  
 39 X 25 CM - 15 IN<sup>3/8</sup> X 9 IN<sup>13/16</sup>

**003944**  
 34 X 23 CM - 13 IN<sup>3/8</sup> X 9 IN<sup>1/8</sup>



**PLAT 003948**  
**À POISSON** 60 X 27 CM - 23 IN<sup>5/8</sup> X 10 IN<sup>5/8</sup>  
 FISH DISH



UNI



MADE IN FRANCE

## SEaux BUCKETS



**SEAU À GLACE 004047**  
 ICE BUCKET 0,5 L - 10 CM - 16 OZ<sup>5/16</sup> - 3 IN<sup>15/16</sup>



**SEAU À GLACE 160899**  
**SANS ANSE** 1 L - 13 CM - 33 OZ<sup>13/16</sup> - 5 IN<sup>11/8</sup>  
 ICE BUCKET WITHOUT HANDLE



**SEAU À CHAMPAGNE 154148**  
**SANS ANSE** 300 CL - 19 CM - 101 OZ<sup>7/16</sup> - 7 IN<sup>1/2</sup>  
 CHAMPAGNE BUCKET WITHOUT HANDLE





**FINITION MÉTAL ARGENTÉ - ARGENTURE CLASSE 1 - 33 MICRONS (POUR LES ARTICLES À USAGE FRÉQUENT)**  
SILVER PLATED FINISH - CLASS 1 SILVERPLATING - 33 MICRONS



**ARGENTURE QUALITÉ HÔTELIÈRE-10 MICRONS**  
SILVER PLATED HOTEL QUALITY-10 MICRONS



**FINITION MIROIR**  
MIRROR FINISH



**FINITION SATINÉE**  
SATIN FINISH



**FINITION CONTRASTE**  
CONTRAST FINISH



**FINITION VINTAGE**  
VINTAGE FINISH



**FORGÉ**  
FORGED

18%

18-10

**ACIER INOXYDABLE**  
STAINLESS STEEL



**EPAISSEUR FOURCHETTE DE TABLE**  
THICKNESS TABLE FORK



**REVÊTEMENT PVD**  
PVD COATING



**PORCELAINE**  
PORCELAIN



**AIMANTÉ**  
WITH MAGNET



**GRÈS**  
STONEWARE



**EMPILABILITÉ**  
STACKABLE



**RÉSISTE AUX CHOCS**  
SHOCK RESISTANT



**RÉSISTE AUX TACHES**  
STAIN RESISTANT



**VERRE**  
GLASS



**SHQ/ SODOCALCIQUE HAUTE QUALITÉ**  
HIGH QUALITY SODA - LIME



**CRISTALLIN HAUTE QUALITÉ**  
HQ LOW LEAD CRYSTAL



**VERRE SOUFLÉ BOUCHE TEINTÉ DANS LA MASSE**  
HAND-BLOWN INTEGRALLY DYED GLASS



**1000 CYCLES GARANTIS MINIMUM**  
1000 WASH CYCLES GUARANTEED



**CRISTALLIN**  
CRYSTALLINE



**SOUFLÉ MÉCANIQUE**  
MACHINE BLOWN



**FINESSE DU BUVANT**  
THICKNESS OF THE RIM



**LÉGÈRETÉ**  
LIGHTNESS



**GARANTIE MICRO-ONDES**  
MICROWAVE SAFE



**GARANTIE LAVE-VAISSELLE**  
DISHWASHER SAFE



**GARANTIE CONGÉLATEUR**  
FREEZER SAFE



**GARANTIE FOUR**  
OVEN SAFE



**JUSQU'À ÉPUISEMENT DES STOCKS**  
UNTIL STOCK LAST



**FABRIQUÉ EN FRANCE**  
MADE IN FRANCE



**FABRIQUÉ EN EUROPE**  
MADE IN EUROPE



**FRANCE USA**

**SIEGE SOCIAL/HEAD OFFICE  
SERVICE CLIENTS/CUSTOMER SERVICES**

rue Guy Degrenne - BP 50056  
14502 Vire cedex  
TEL : +33 (0)2 31 66 44 15

OTHER COUNTRIES  
TEL : +33 (0)2 31 66 44 00

[infohotel@degrenne.fr](mailto:infohotel@degrenne.fr)

**FILIALE USA/US SUBSIDIARY**

DNA/DEGRENNÉ NORTH AMERICA INC.  
301 OXFORD VALLEY ROAD, SUITE 1903-B,  
YARDLEY, PA 19067

TEL : 732 565 0820  
FAX : 732 565 0828

[csrv.dna@degrenneparis.com](mailto:csrv.dna@degrenneparis.com)  
[www.degrennenorthamerica.com](http://www.degrennenorthamerica.com)

**SHOWROOM (BY APPOINTMENT)**  
41 Madison Avenue, 15th Floor  
NEW YORK, NY 10010

[www.pro.degrenne.fr](http://www.pro.degrenne.fr)





**FRANCE**

infohotel@degrenne.fr  
Tel : +33 (0)2 31 66 44 15

**OTHER COUNTRIES/OTROS PAISES**

infohotel@degrenne.fr  
Tel : +33 (0)2 31 66 44 00

**FILIALE USA/US SUBSIDIARY  
DEGRENNÉ NORTH AMERICA INC.  
301 OXFORD VALLEY ROAD  
SUITE 1903-B  
YARDLEY, PA 19067**

csrv.dna@degrennenorthamerica.com  
[www.degrennenorthamerica.com](http://www.degrennenorthamerica.com)

Tel : 732 565 0820

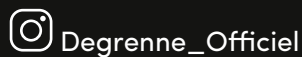

[www.pro.degrenne.fr](http://www.pro.degrenne.fr)